

## Avarit

Giuseppe Viganò



Customisation is the key word that distinguishes the Avarit modular sofa collection. Customers can put together their desired composition starting with a fixed base and backrest, then adding the important seat cushions and down backrest that make up the actual soul of the sofa. In addition, it is possible to choose from an extensive range of upholstery covers in fabric and leather, which can be mixed and matched in total freedom. The feet are made of metal painted in anthracite grey, white, dove-grey, brown or black.

### UPHOLSTERY:

fabric

leather

### FEET:

matt anthracite grey painted metal

matt dove grey painted metal

matt brown painted metal

matt white painted metal

matt black painted metal

Divano 322 - variante A  
Sofa

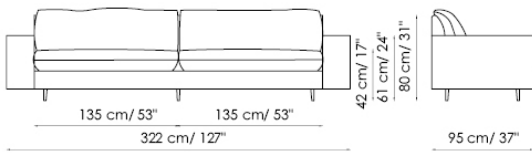

Divano 322 - variante B  
Sofa

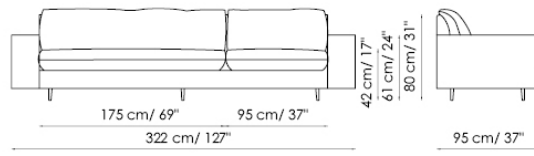

Divano 282 - variante A  
Sofa

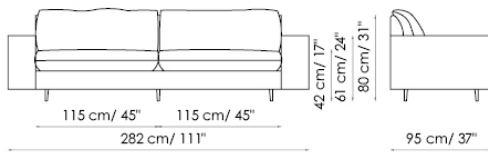

Divano 282 - variante B  
Sofa

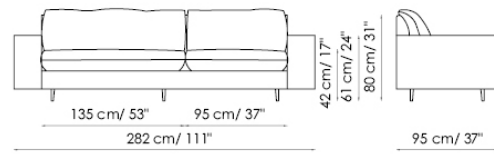

Divano 242  
Sofa

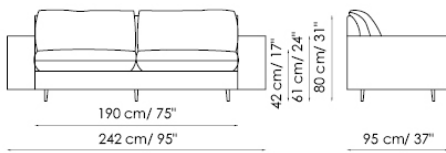

Divano 227  
Sofa

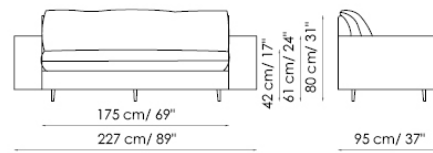

Divano 207  
Sofa

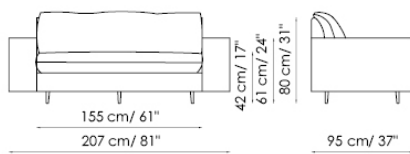

Divano 187  
Sofa

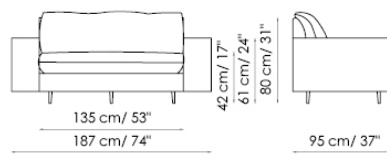

Terminale 256  
End section sofa

sx  
left

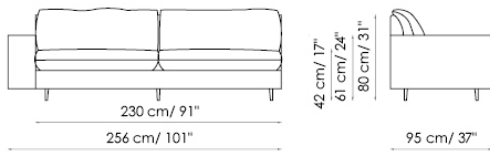

Terminale 216  
End section sofa

sx  
left

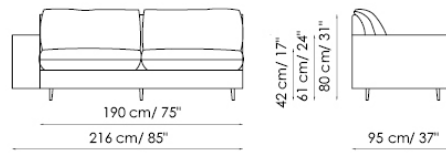

Terminale 201  
End section sofa

sx  
left

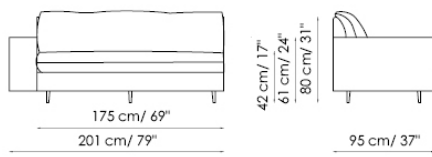

Centrale 270  
Center section

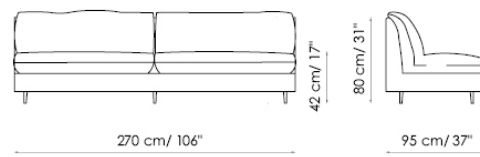

Centrale 230  
Center section

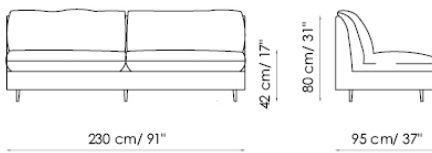

Centrale 190  
center section

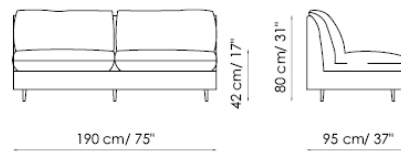

Centrale 175  
Center section

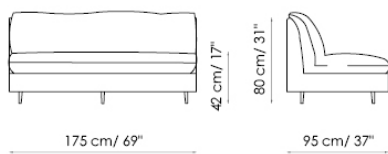

Centrale 155  
Center section

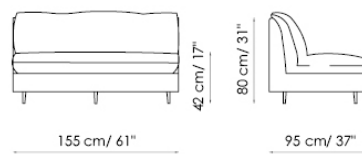

Centrale 135  
Center section

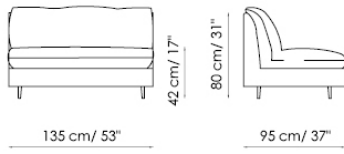

Centrale 115  
center section

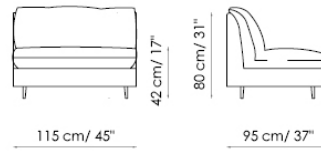

Centrale 95  
center section

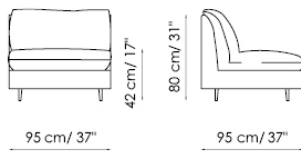

Chaise longue  
sx  
left

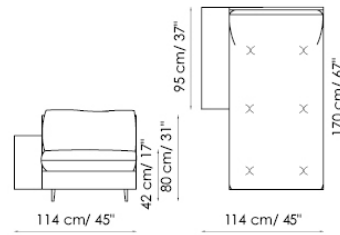

isola  
sx  
left

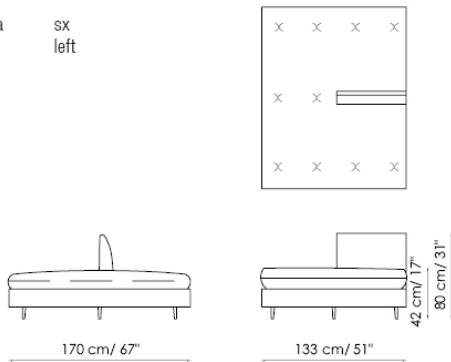

Pouf 95x95

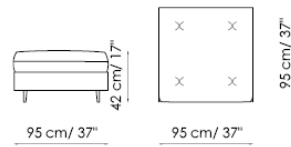

Pouf tavolino  
pouf small table

