

Playa 203

PLAYA COLLECTION:

Playa 203, Playa 203C, Playa 204, Playa 204C, Playa 205,

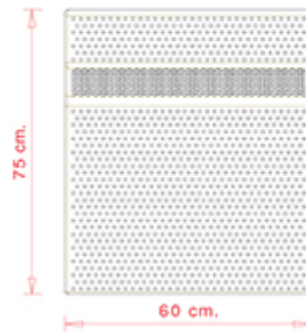
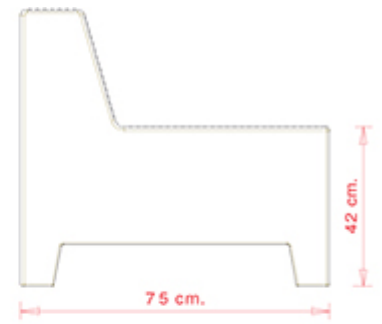
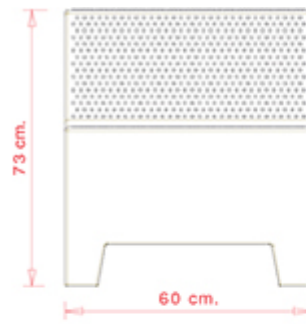

Modular seating system, rotational moulding polyethylene. Linear module.

WEIGHT

9 kg

PACK

0,58 m³

PIECES PER BOX

2

FINISHES SEATING

PE ROTO-MOULDING POLYETHYLENE



USES

coffee & restaurants, hotels, educational, entertainment,

Playa 203C

PLAYA COLLECTION:

Playa 203, Playa 203C, Playa 204, Playa 204C, Playa 205,

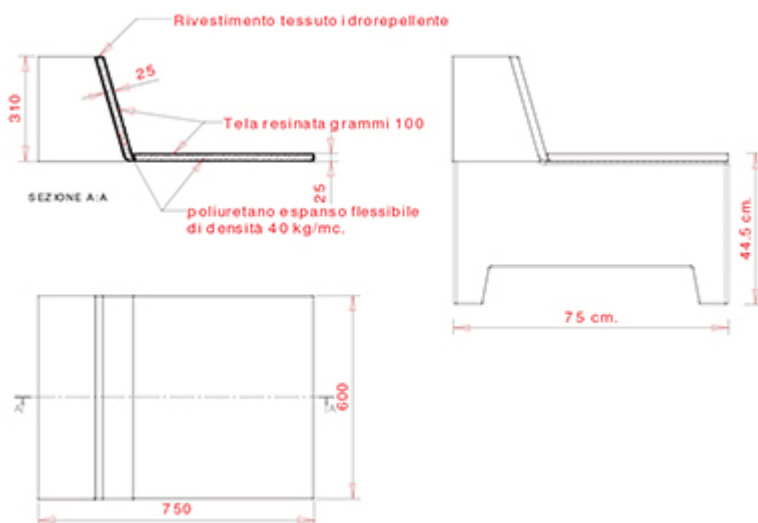

Optional cushion for outdoor use, to be removed in case of bad weather. Linear module.

FINISHES SEATING

TE FABRICS



PE ROTO-MOULDING POLYETHYLENE



USES

coffee & restaurants, hotels, educational, entertainment,

Playa 204

PLAYA COLLECTION:

Playa 203, Playa 203C, Playa 204, Playa 204C, Playa 205,

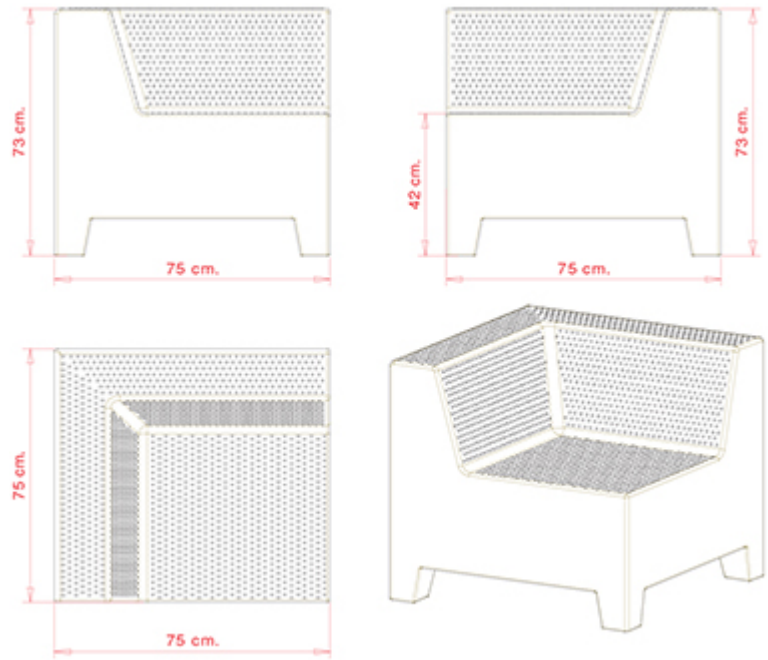

Modular seating system, rotational moulding polyethylene. Corner module.

WEIGHT

12 kg

PACK

0,47 m³

PIECES PER BOX

1

FINISHES SEATING

PE ROTO-MOULDING POLYETHYLENE



USES

coffee & restaurants, hotels, educational, entertainment,

Playa 204C

PLAYA COLLECTION:

Playa 203, Playa 203C, Playa 204, Playa 204C, Playa 205,

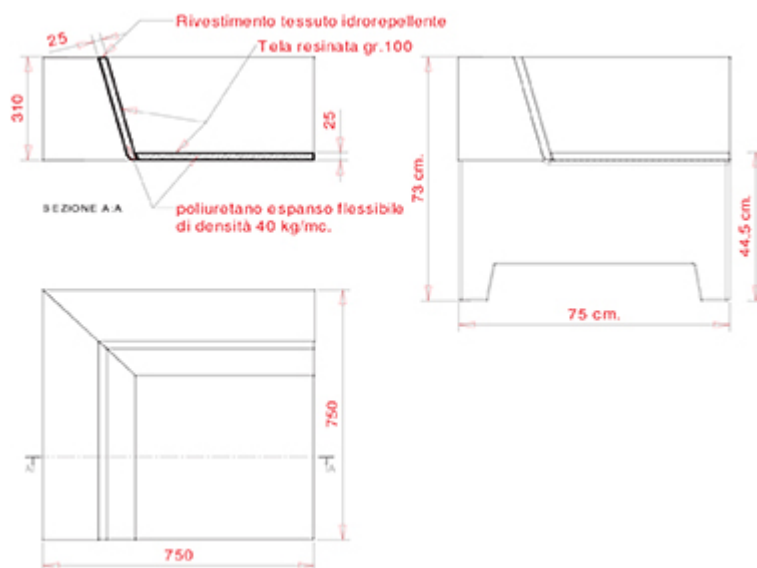

Optional cushion for outdoor use, to be removed in case of bad weather. Corner module.

WEIGHT

12 kg

PACK

0,47 m³

PIECES PER BOX

1

FINISHES SEATING

TE FABRICS



PE ROTO-MOULDING POLYETHYLENE



USES

coffee & restaurants, hotels, educational, entertainment,

Playa 205

PLAYA COLLECTION:

Playa 203, Playa 203C, Playa 204, Playa 204C, Playa 205,

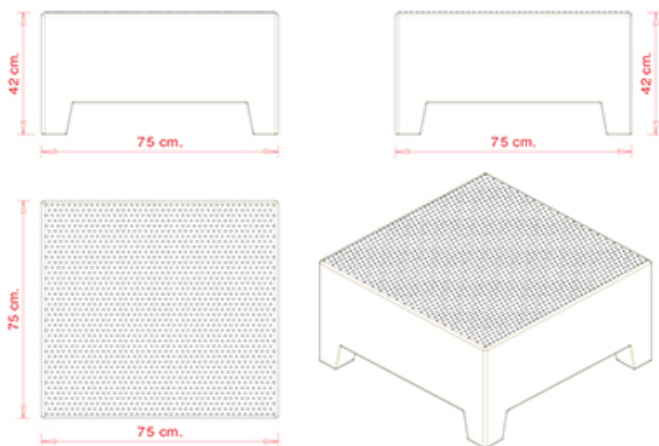

Multiple seating system, rotational moulding polyethylene. Pouf module.

WEIGHT

8,6 kg

PACK

0,28 m³

PIECES PER BOX

2

FINISHES SEATING

PE ROTO-MOULDING POLYETHYLENE



USES

coffee & restaurants, hotels, educational, entertainment,

