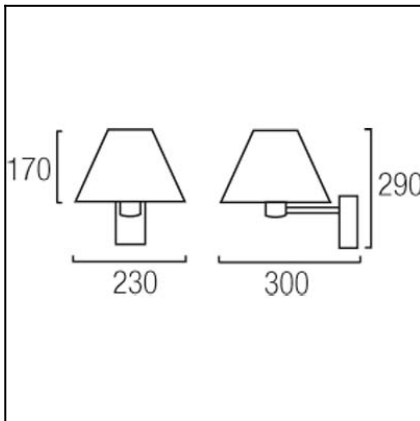

**Design by Benedito Design**

The photograph may not match the reference exactly. Please read the product description to identify the finish.

**TECHNICAL CHARACTERISTICS**

Type:	Wall fixture
IP Protection degrees:	IP20
Lampholder:	1 x G24d1
Power (W):	G24d1 13W
Voltage / Frequency:	220-240V/50Hz
Warranty (Years):	2
Units per box:	2
Net Weight (Kg):	0.74
EAN:	8435111021910,00

**MATERIALS / FINISHES**

**Structure material:** Aluminium  
**Structure finish:** Satin nickel

**GEAR**

Gear included: Yes, Magnetic

Download photometric file .ldt / .ies

**PAN-103-14****Diffuser material:**

Fabric shade

**Diffuser finish:**

White

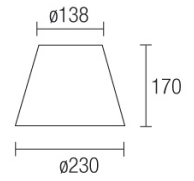
**PAN-103-20****Diffuser material:**

Fabric shade

**Diffuser finish:**

Beige

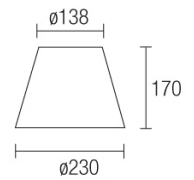

<b>Luminaria</b>		<b>Ensayo</b>		<b>Lámpara</b>	
Código	05-2272-U4-82	Código	05-2276-S8-82	Código	PL-C13W/840/2P
Nombre	Aplique HOTELS 13W TC-D G24d-1	Nombre	Aplique HOTELS 13W TC-D G24d-1	Número	1
Familia	- LEDS-C4	Fecha	23-04-2010	Posición	Universal
Eficiencia	60.82%	Sist. de Coorden.	C-G	Flujo Total	900.00 lm
Valor Máximo	103.73 cd	Posición	C=300.00 G=40.00	Sim. en los planos	270-90

Diam=230mm

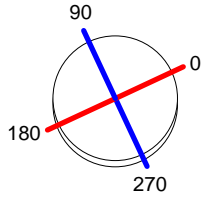

Semiplanos C

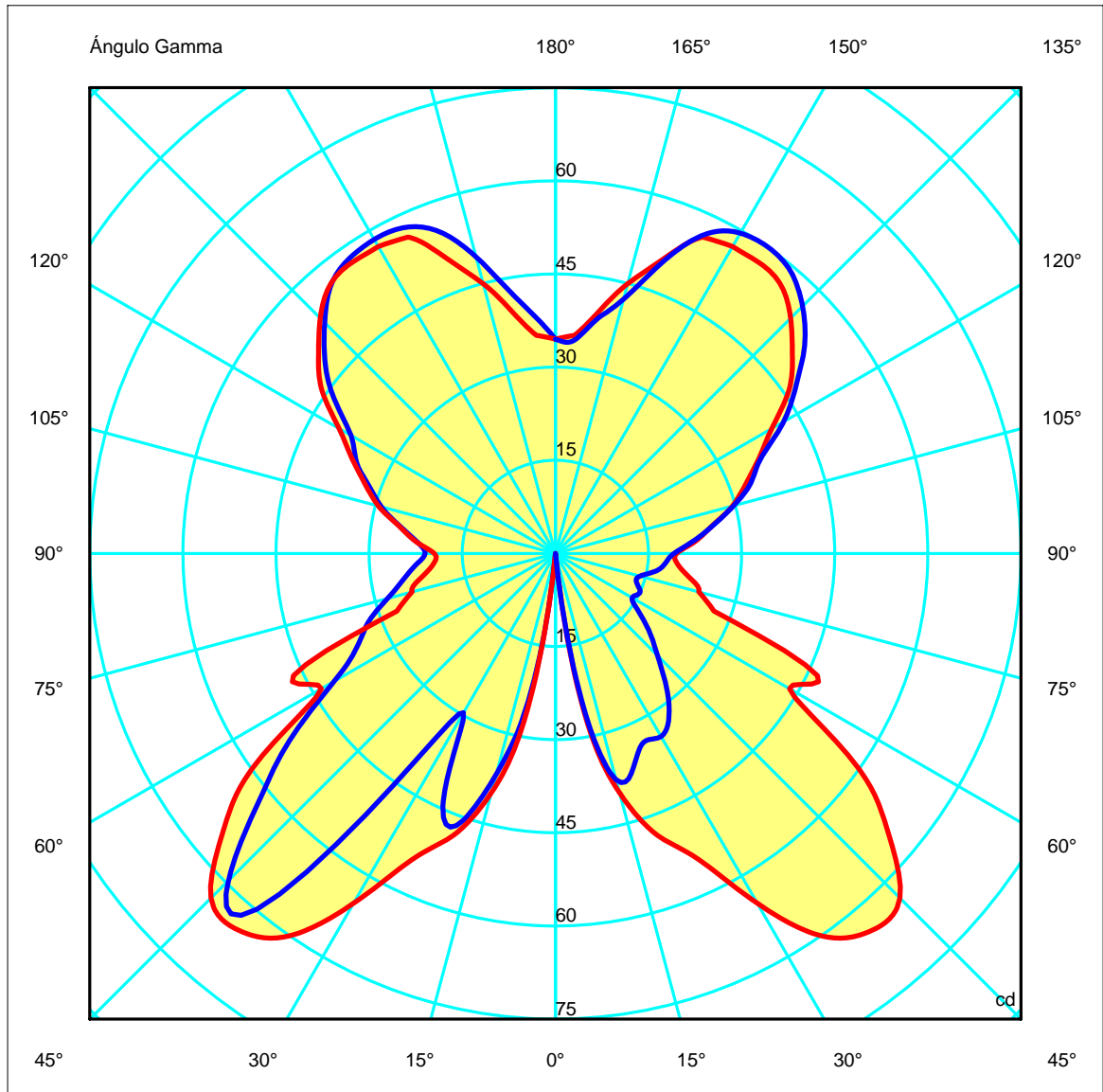
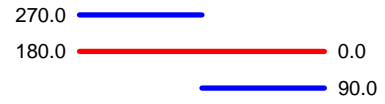

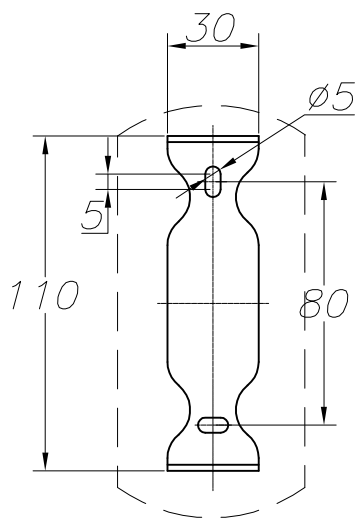
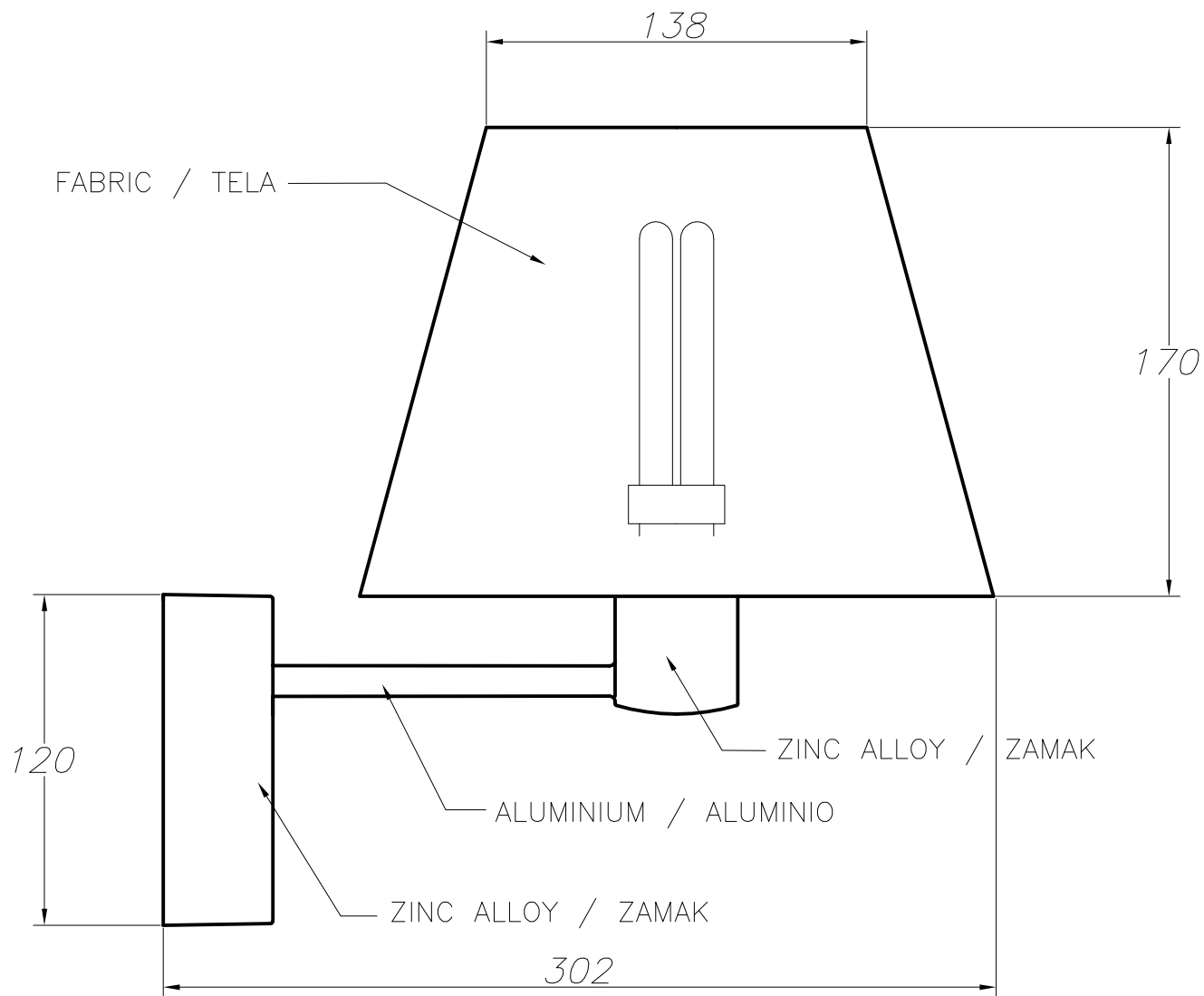

①

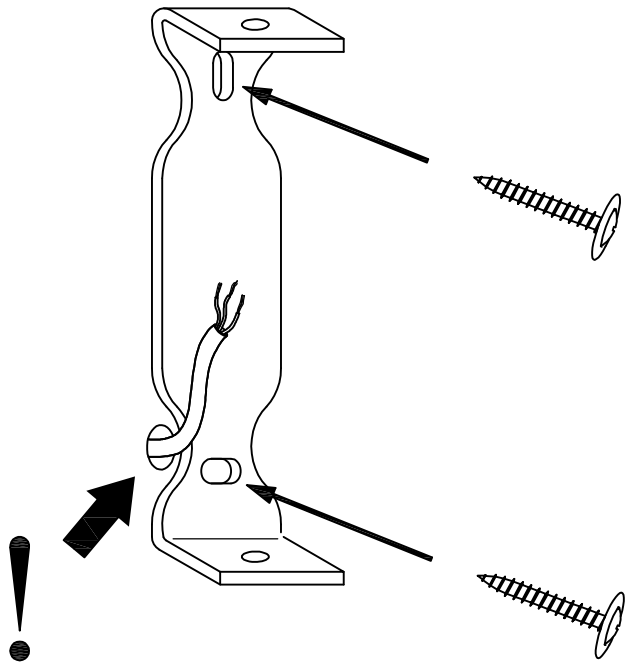

②

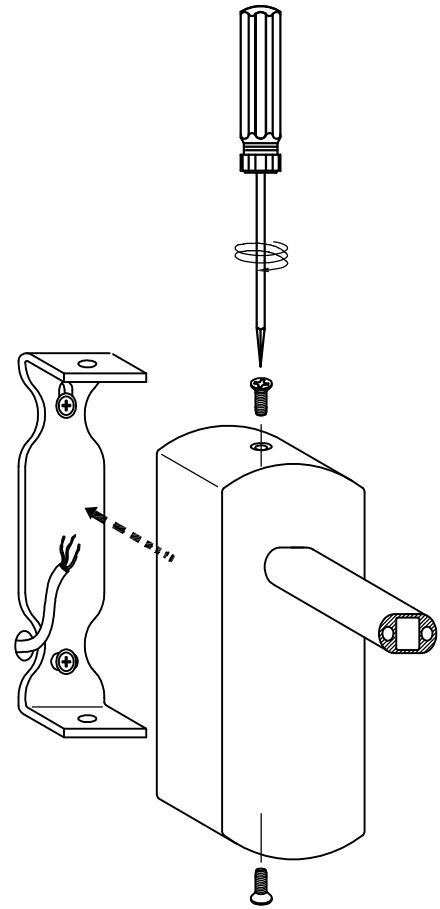

③

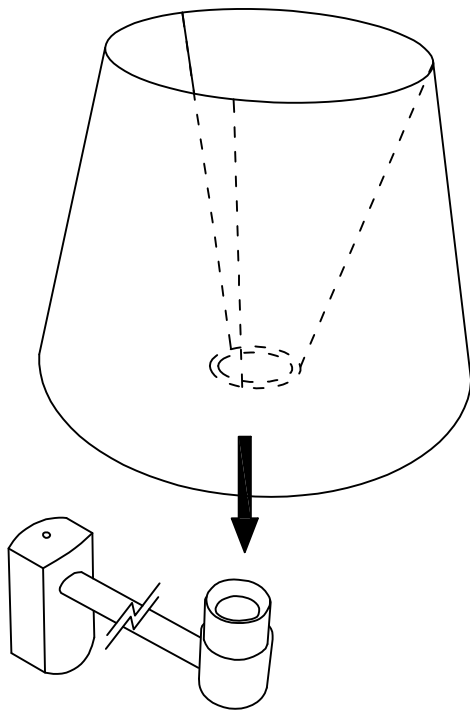

④

