

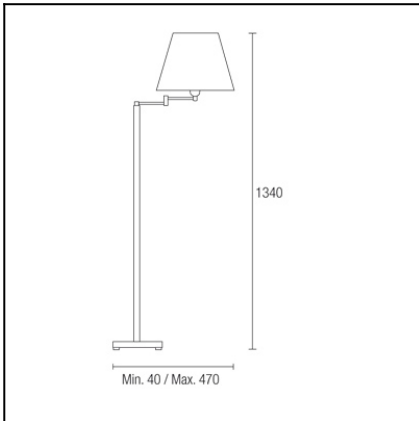

The photograph may not match the reference exactly. Please read the product description to identify the finish.

**TECHNICAL CHARACTERISTICS**

Type:	Floor lamp
IP Protection degrees:	IP20
Lampholder:	1 x E27
Power (W):	E27 MAX 60W
Total power consumption (W):	60
Voltage / Frequency:	220-240V/50-60Hz
Warranty (Years):	2
Units per box:	4
Net Weight (Kg):	4.915
EAN:	8435071499996,00
Stability:	>15°

**MATERIALS / FINISHES**

**Structure material:** Steel

**Structure finish:** Satin nickel

[Download photometric file .ldt / .ies](#)

**PAN-184-14**

**Structure material:** Steel  
**Structure finish:** White  
  
**Diffuser material:** Fabric shade  
**Diffuser finish:** White

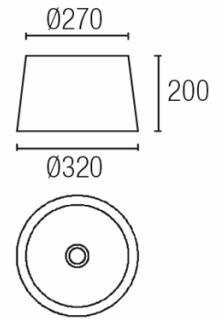
**PAN-184-BY**

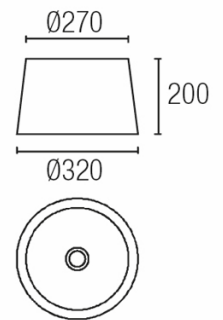

**Structure material:** Steel  
**Structure finish:** White  
  
**Diffuser material:** Fabric shade  
**Diffuser finish:** Sandblasted



IP20

**PAN-185-J6**

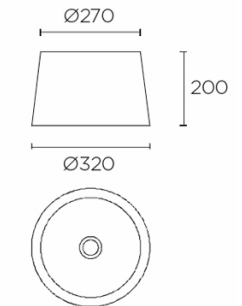
**Structure material:** Steel  
  
**Diffuser material:** Fabric shade  
**Diffuser finish:** Brown

**PAN-181-14**

**Structure material:** Steel  
**Structure finish:** White  
  
**Diffuser material:** Fabric shade  
**Diffuser finish:** White

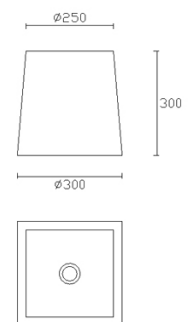

IP20

**PAN-181-BY**



**Structure material:** Steel  
**Structure finish:** White  
  
**Diffuser material:** Fabric shade  
**Diffuser finish:** Sandblasted

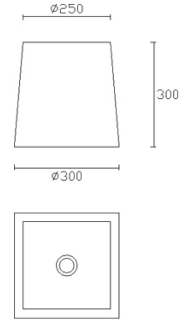

IP20

**PAN-189-20**



**Structure material:** Steel  
**Structure finish:** White  
  
**Diffuser material:** Fabric shade  
**Diffuser finish:** Beige

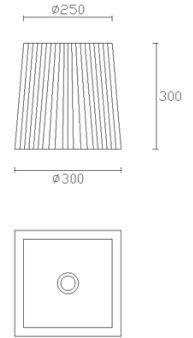

IP20

**PAN-220-V7**

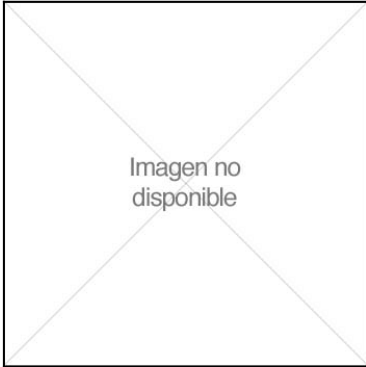

**Structure material:** Steel  
**Structure finish:** Brown  
  
**Diffuser material:** PVC  
**Diffuser finish:** Antique copper

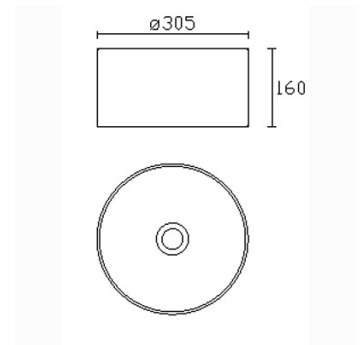

IP20

**PAN-182-T001**



**Structure material:** Steel  
**Structure finish:** White  
  
**Diffuser material:** Fabric shade  
**Diffuser finish:** Beige

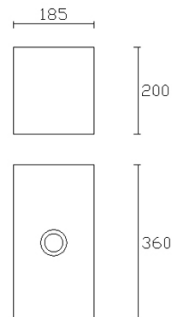

IP20

PAN-182-14

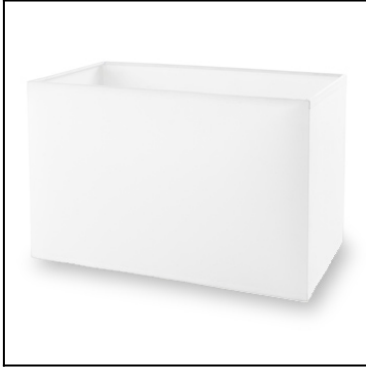

**Structure material:** Steel  
**Structure finish:** White  
**Diffuser material:** Fabric shade  
**Diffuser finish:** White

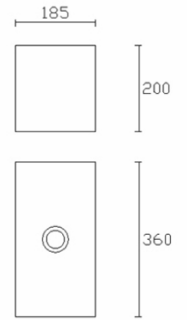

PAN-182-BY



**Structure material:** Steel  
**Structure finish:** White  
**Diffuser material:** Fabric shade  
**Diffuser finish:** Sandblasted

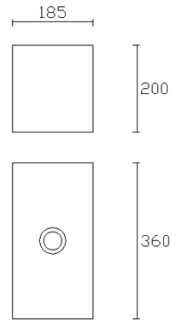

IP20

PAN-183-14

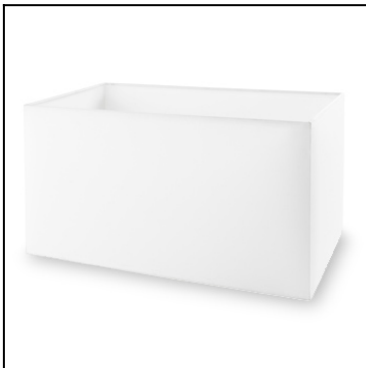

**Structure material:** Steel  
**Structure finish:** White  
**Diffuser material:** Fabric shade  
**Diffuser finish:** White

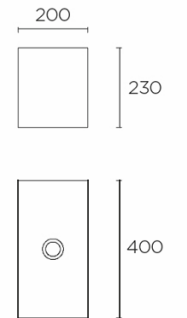

PAN-183-BY



**Structure material:** Steel  
**Structure finish:** White  
**Diffuser material:** Fabric shade  
**Diffuser finish:** Sandblasted

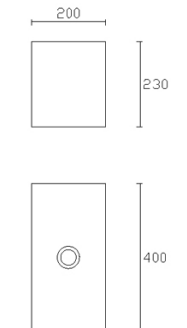

IP20

PAN-183-T001



**Structure material:**

Steel

**Structure finish:**

White

**Diffuser material:**

Fabric shade

**Diffuser finish:**

Beige

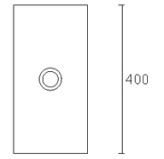
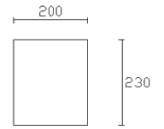

<b>Luminaria</b>		<b>Ensayo</b>		<b>Lámpara</b>	
Código	176-NS	Código	172-NS	Código	CLAS A CL 60
Nombre	Pie DOVER 1x60W E27 incand	NombreAplic	DOVER 60W E27 incan	Número	1
Familia	- LEDS-C4	Fecha	22-04-2010	Posición	Universal
Eficiencia	67.22%	Sist. de Coordin.	C-G	Flujo Total	710.00 lm
Valor Máximo	100.07 cd	Posición	C=90.00 G=40.00	Bisimétrico	

Diam=230mm

Semiplanos C

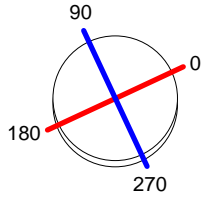

180.0 ——— 0.0  
270.0 ——— 90.0

