

Design by Estudi Ribaudí

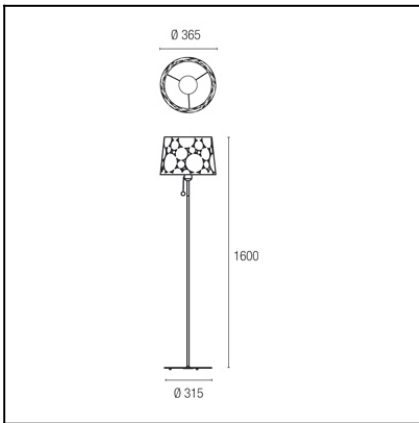

The photograph may not match the reference exactly. Please read the product description to identify the finish.



### TECHNICAL CHARACTERISTICS

|                              |                  |
|------------------------------|------------------|
| Type:                        | Floor lamp       |
| IP Protection degrees:       | IP20             |
| Lampholder:                  | 1 x E27          |
| Power (W):                   | E27 MAX 100W     |
| Total power consumption (W): | 100              |
| Voltage / Frequency:         | 220-240V/50-60Hz |
| Warranty (Years):            | 2                |
| Units per box:               | 1                |
| Net Weight (Kg):             | 8.29             |
| EAN:                         | 8435111073919,00 |

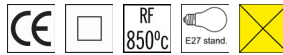

### MATERIALS / FINISHES

|                            |                      |                           |             |
|----------------------------|----------------------|---------------------------|-------------|
| <b>Structure material:</b> | Steel                | <b>Diffuser material:</b> | Steel shade |
| <b>Structure finish:</b>   | Matt white<br>Chrome | <b>Diffuser finish:</b>   | White       |

E-27 100W

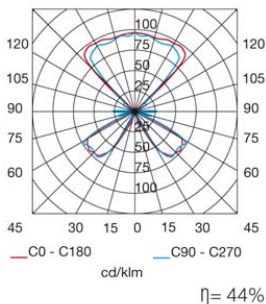

Download photometric file .ldt /.ies

| Luminaria    |                              | Ensayo            |                              | Lámpara     |                   |
|--------------|------------------------------|-------------------|------------------------------|-------------|-------------------|
| Código       | 25-4343-05-05                | Código            | 25-4343-05-05                | Código      | STANDARD GOC 100W |
| Nombre       | Pie 1x100W incandescente E27 | Nombre            | Pie 1x100W incandescente E27 | Número      | 1                 |
| Familia      | - LEDS-C4                    | Fecha             | 25-02-2010                   | Posición    |                   |
| Eficiencia   | 44.04%                       | Sist. de Coordin. | C-G                          | Flujo Total | 930.00 lm         |
| Valor Máximo | 97.27 cd                     | Posición          | C=0.00 G=145.00              | Bisimétrico |                   |

Diam=365mm

Semiplanos C

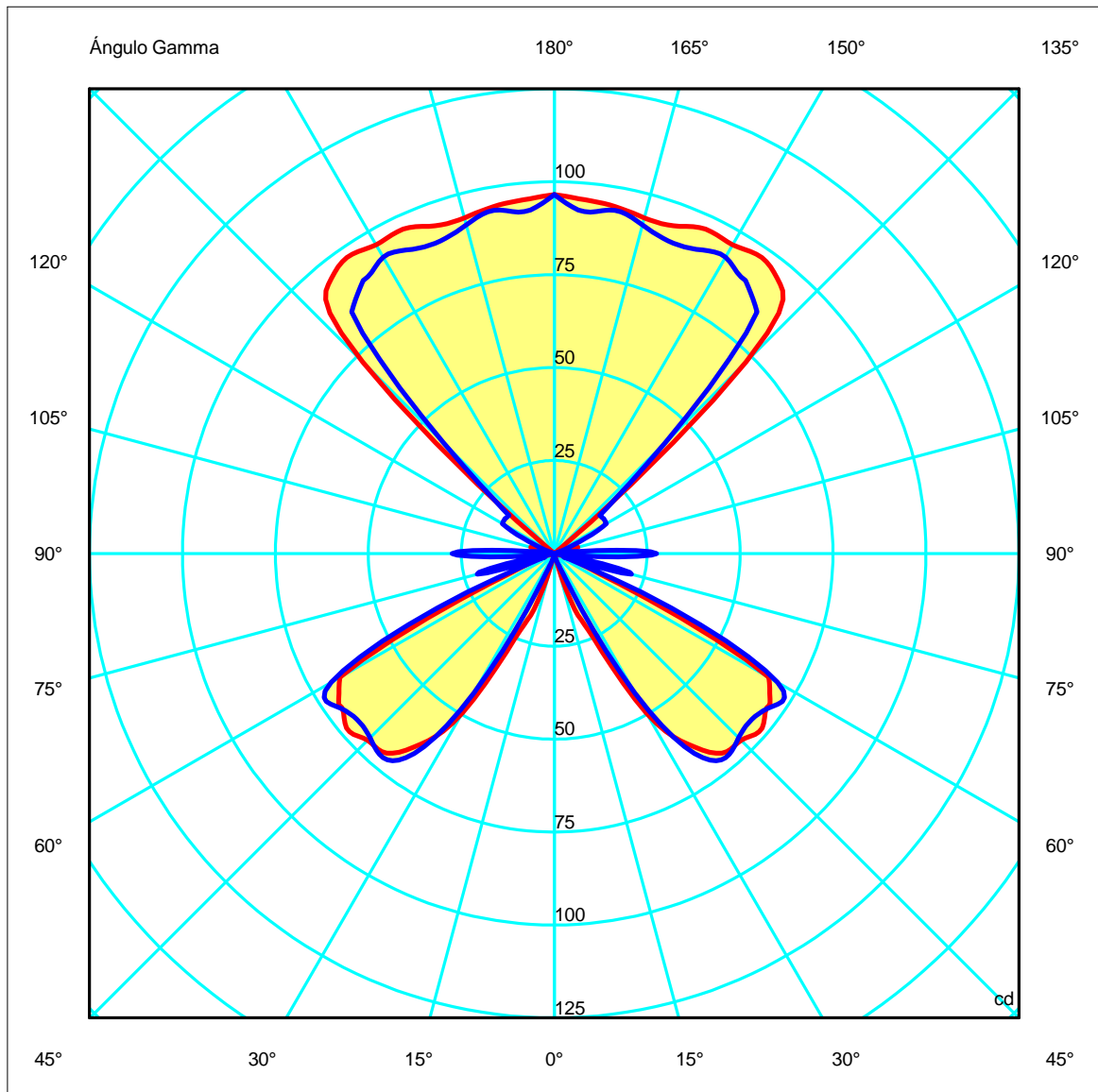
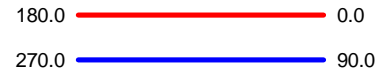
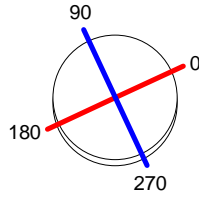

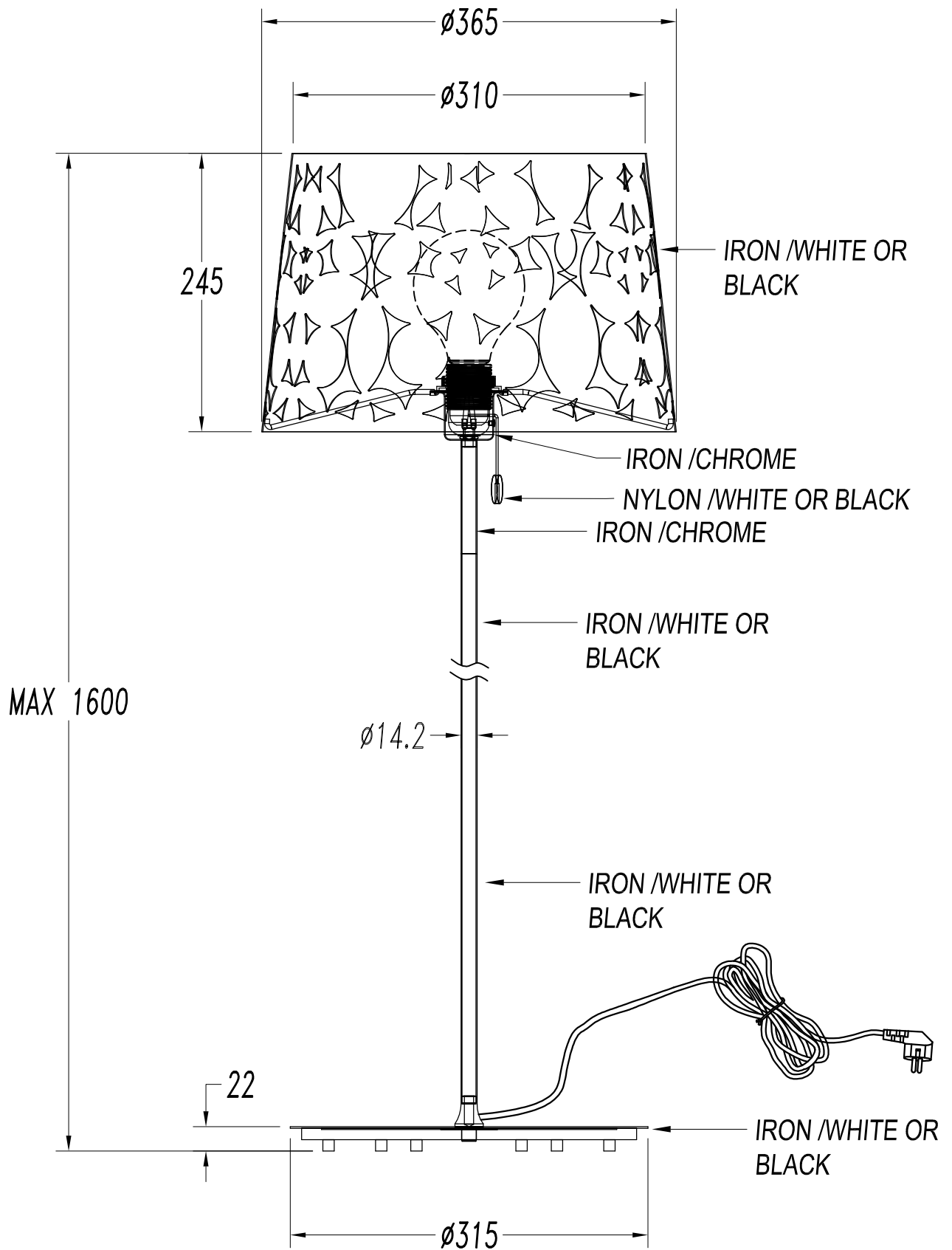

**1**

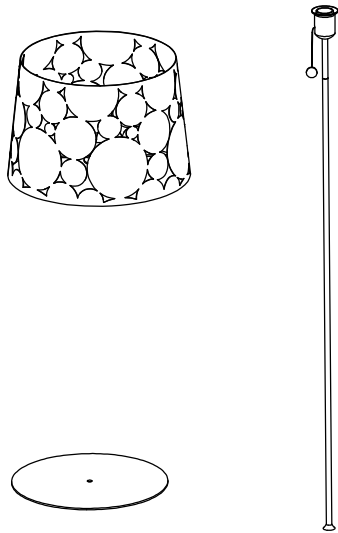

**2**

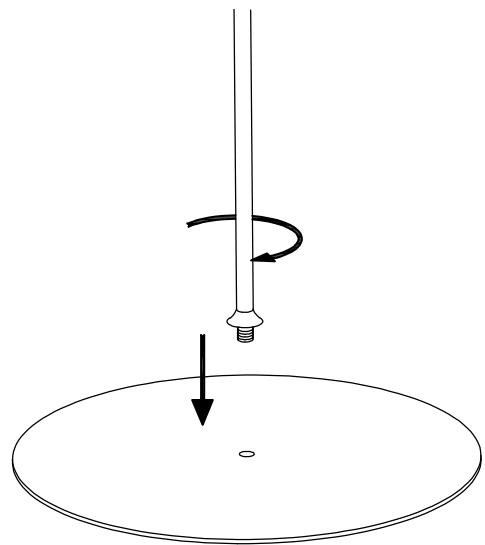

**3**

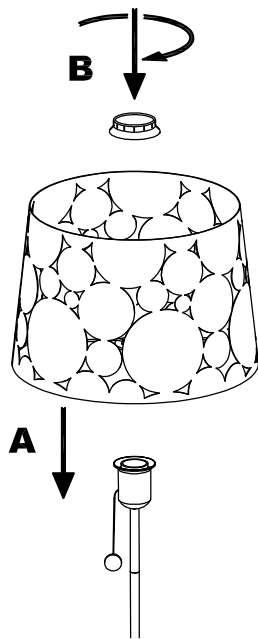

**4**

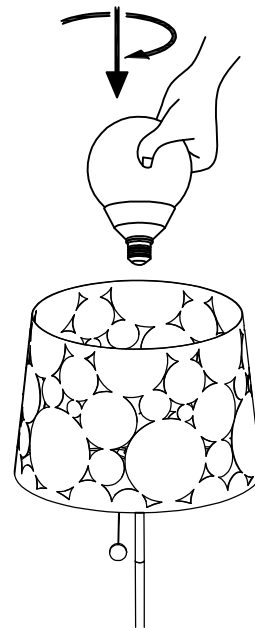

**5**

