

OUT 

MÜLLER 55-9556-Z5-M3

Design by Francesc Vilaró

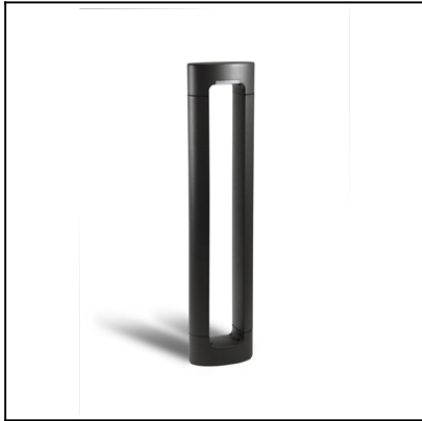

The photograph may not match the reference exactly. Please read the product description to identify the finish.

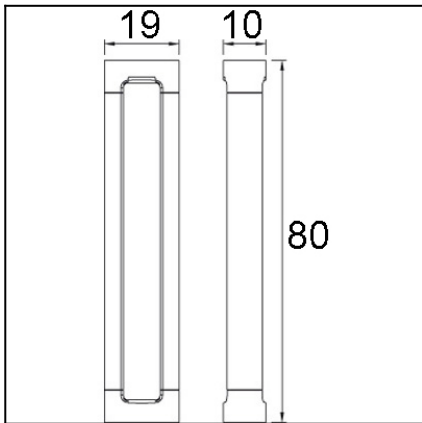

TECHNICAL CHARACTERISTICS

Type:	Beacon
IP Protection degrees:	IP54
IK Protection degrees:	IK08
Lampholder:	1 x GX53
Power (W):	GX53 max. 13W
Voltage / Frequency:	220-240V/50-60Hz
Warranty (Years):	2
Units per box:	2
Net Weight (Kg):	3.46
EAN:	8435111089071

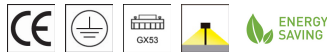

MATERIALS / FINISHES

Structure material: High purity aluminium
Structure finish: Urban grey

Diffuser material: Polycarbonate
Diffuser finish: Matt

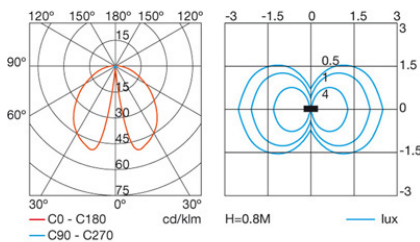

Download photometric file .ldt /.ies

Luminaria		Ensayo		Lámpara		
Código	55-9556	Código	10-9556	Código	DOWNLIGHTER 7W/827	
Nombre	Baliza fluor 7W GX5.3 dif opal	Nombre	Baliza fluor 7W GX53 dif. opal	Número	1	
Familia	- LEDS-C4	Fecha	11-11-2011	Posición	Universal	
Rendimiento	32.27%	Sist. de Coorden.	C-G	Flujo Total	250.00 lm	
Valor Máximo	50.13 cd	Posición	C=0.00 G=15.00	Bisimétrico		
Luminaria Rectangular	Longit.	185 mm	Anchura	65 mm	Altura	805 mm
Área Luminosa Rectangular	Longit.	65 mm	Anchura	105 mm	Altura	5 mm
Área Luminosa Horizontal		0.006825 m2	Área Emisión sobre Pl. 180°			0.000325 m2
Área Emisión sobre Pl. 0°		0.000325 m2	Área Emisión sobre Pl. 270°			0.000525 m2
Área Emisión sobre Pl. 90°		0.000525 m2	Área de deslumbramiento a 76°			0.001966 m2
Tipo de Simetría	Bisimétrico	Máximo Ángulo Gamma	Flujo de Ensayo	180	250.00 lm	
Distancia de Ensayo	6.44	Tensión de alimentación	Corr. aliment.	230.00 V		
Operador	Asselum T2	Fotocélula		PRC		
Temperatura	22.00 °C					
Humedad	50.00 %					
Notas						

Lámparas de la Luminaria					
Familia	Código	Nombre	Flujo/lm	Pot.W	Cant.
PHILIPS 2005 ILCOS FBT,G,C,FSQ	DOWNLIGHTER 7W/827	DOWNLIGHTER 7W/827 GX53	250.00	7.00	1
C.I.E.	48 79 94 95 32	D DIN 5040		A31	
F UTE	0.31 E + 0.02 T	B NBN		BZ 4 / 1.5 / BZ 5	

185mm x 65mm

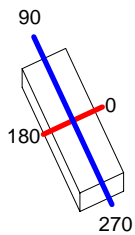

Semiplanos C

180.0 — 0.0

270.0 — 90.0

ULOR 1.61 %

DLOR 30.66 %

RN 4.98 %

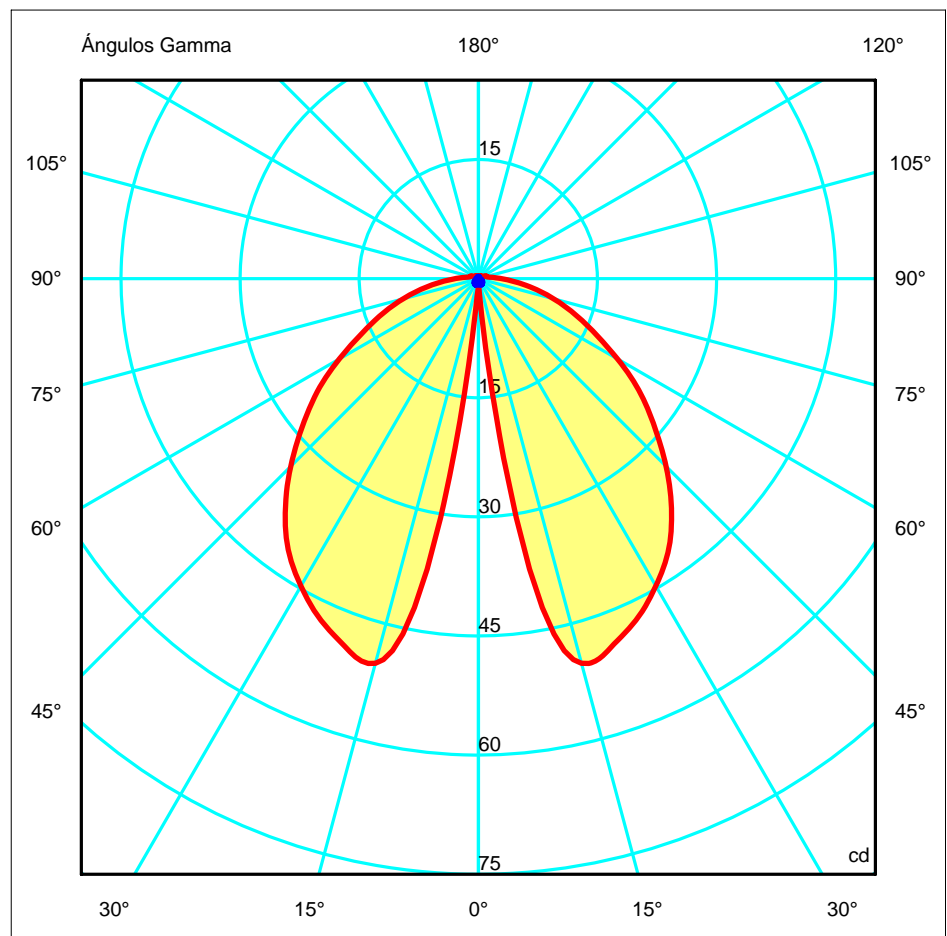

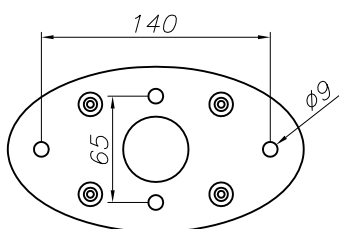
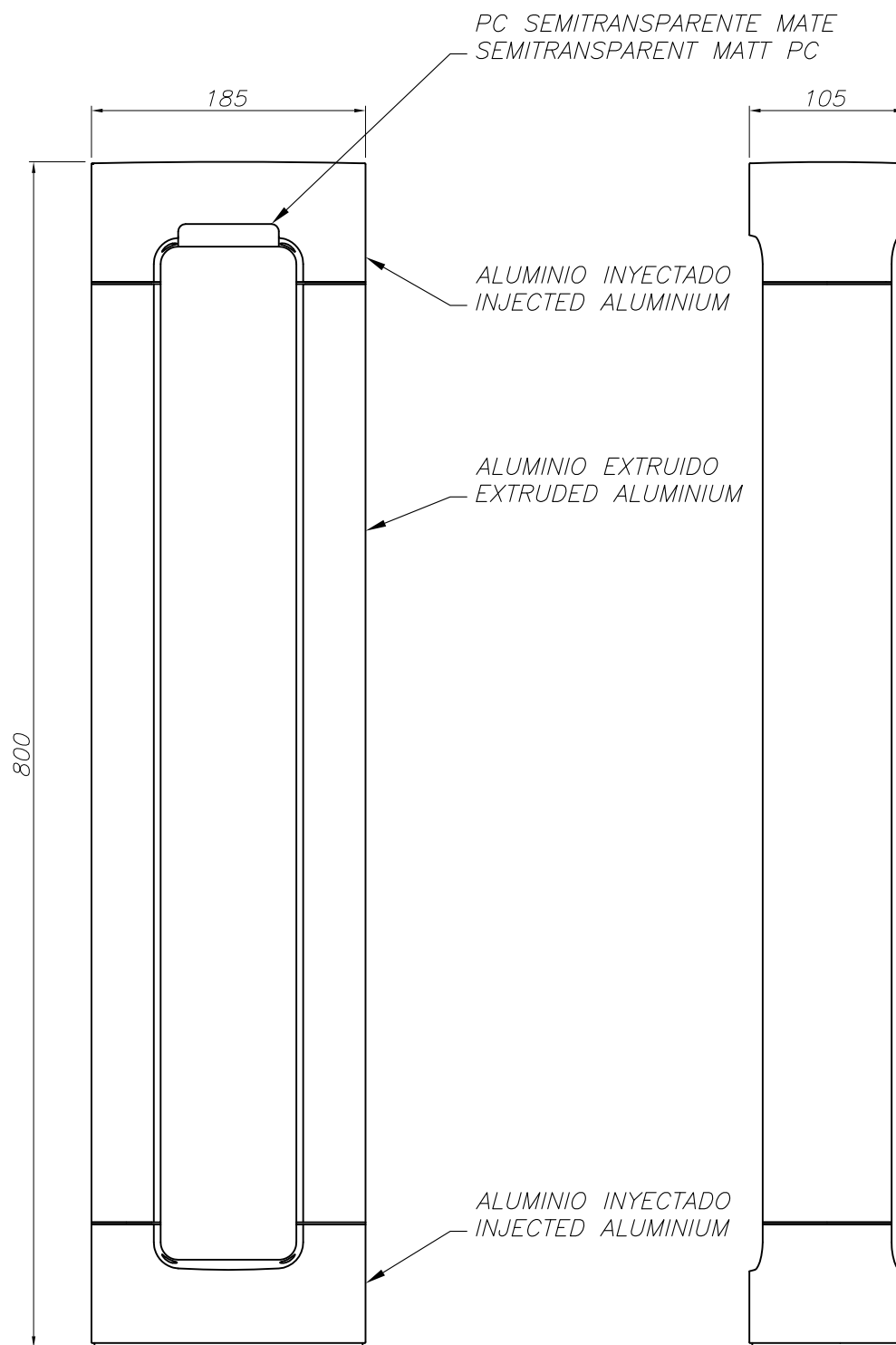

PLANTILLA DE INSTALACIÓN
INSTALLATION TEMPLATE

