

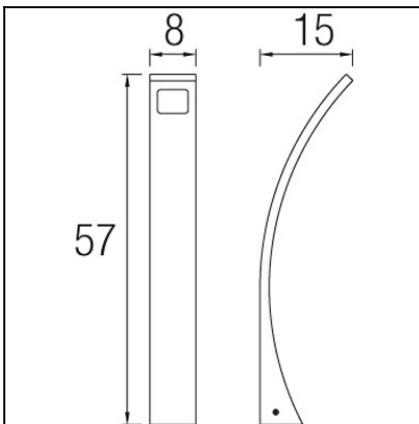

The photograph may not match the reference exactly. Please read the product description to identify the finish.



### TECHNICAL CHARACTERISTICS

Type:	Beacon
IP Protection degrees:	IP44
Bulb:	3 x LED Cree. Neutral white - 4000K
Power (W):	3W
Luminous efficacy (Lm/W):	122
CRI:	75
Voltage / Frequency:	100-240V/50-60Hz
Warranty (Years):	2
Option to extend the guarantee:	Yes, 5 years
Units per box:	4
Net Weight (Kg):	0.84
EAN:	8435111089682

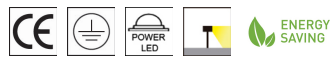

### MATERIALS / FINISHES

<b>Structure material:</b>	Injected aluminium	<b>Diffuser material:</b>	Polycarbonate
<b>Structure finish:</b>	Grey	<b>Diffuser finish:</b>	Opal

### GEAR

Multi-voltage electronic gear included (110-240 V / 50-60 Hz)

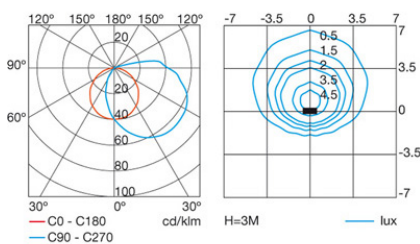

Download photometric file .ldt / .ies

Luminaria		Ensayo		Lámpara		
Código	55-9602	Código	55-9602	Código	05-9602	
Nombre	Aplique leds difusor opal	Nombre	Aplique leds difusor opal	Número	1	
Familia	- LEDS C4 LEDS	Fecha	18-11-2011	Posición	Universal	
Rendimiento	100.00%	Sist. de Coorden.	C-G	Flujo Total	170.50 lm	
Valor Máximo	65.40 cd	Posición	C=90.00 G=45.00	Sim. en los planos 270-90		
Luminaria Rectangular	Longit.	575 mm	Anchura	75 mm	Altura	100 mm
Área Luminosa Rectangular	Longit.	50 mm	Anchura	50 mm	Altura	0 mm
Área Luminosa Horizontal	0.002500 m2		Área Emisión sobre Pl. 180°		0.000000 m2	
Área Emisión sobre Pl. 0°	0.000000 m2		Área Emisión sobre Pl. 270°		0.000000 m2	
Área Emisión sobre Pl. 90°	0.000000 m2		Área de deslumbramiento a 76°		0.000605 m2	
Tipo de Simetría	Sim. en los planos 270-90		Máximo Ángulo Gamma		180	
Distancia de Ensayo	6.44		Flujo de Ensayo		170.50 lm	
Operador	Asselum T2		Tensión de alimentación		230.00 V	
Temperatura	22.00 °C		Corr. aliment.			
Humedad	50.00 %		Fotocélula		PRC	
Notas						

Lámparas de la Luminaria					
Familia	Código	Nombre	Flujo/lm	Pot.W	Cant.
- LEDS C4 LEDS	05-9602	Lámpara led blanco	170.50	5.00	1
C.I.E.	36 63 85 89 100	D DIN 5040		B21	
F UTE	0.89 H + 0.11 T	B NBN		BZ 6	

575mm x 75mm

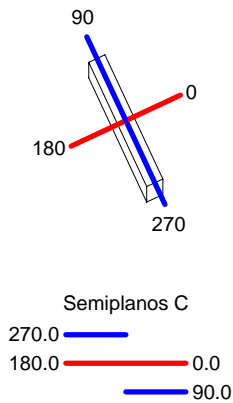

ULOR 11.18 %  
DLOR 88.82 %  
RN 11.18 %

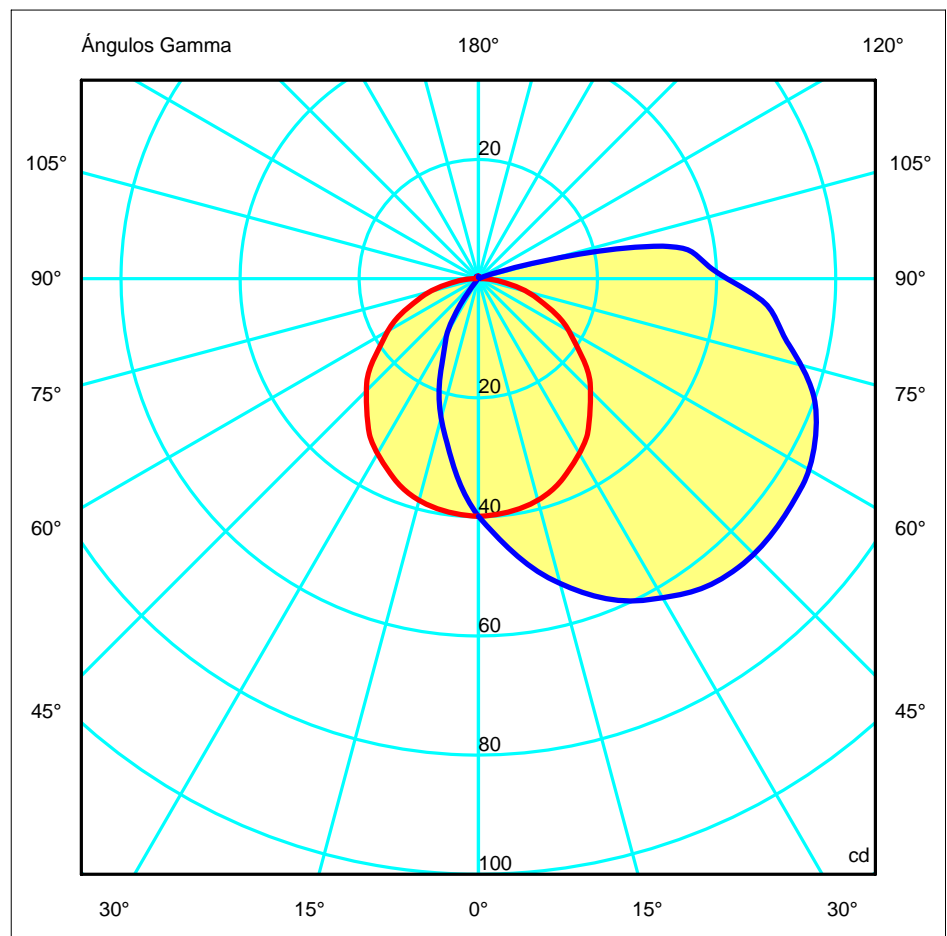

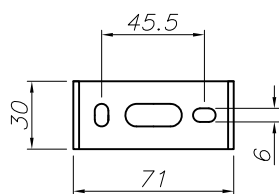
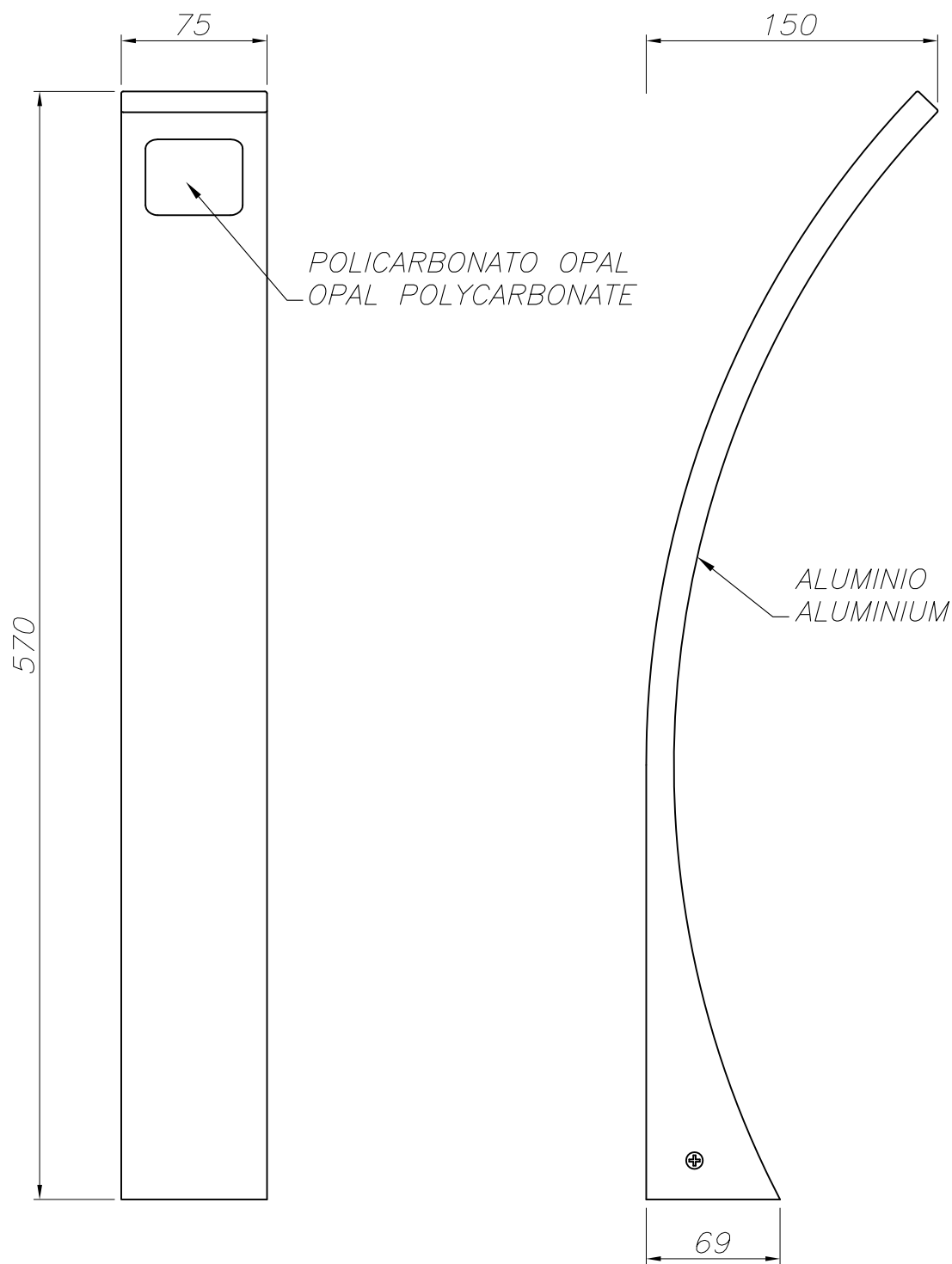

PLANTILLA DE INSTALACIÓN  
INSTALLATION TEMPLATE

