

# DV805

WORKSTATIONS

**02**  
TREKO

design  
Antonio Morello

INDEX >

04 | 09

.01



10 | 15

.02



16 | 23

.03



.04



.06

38 | 43



.07

44 | 49



.08

50 | 55

24 | 31



.05



32 | 37



.09

56 | 63





# DV805 TREKO

**Elegante semplicità.**

Praticità, attualità e flessibilità, sono i plus principali che consentono di arredare i moderni spazi di lavoro con estrema semplicità e funzionalità.

**Elegant simplicity.**

Practicality, flexibility and timeliness, are the main features that allow to furnish modern working environments with extreme simplicity and functionality.

# DV805 TREKO

# BASIC

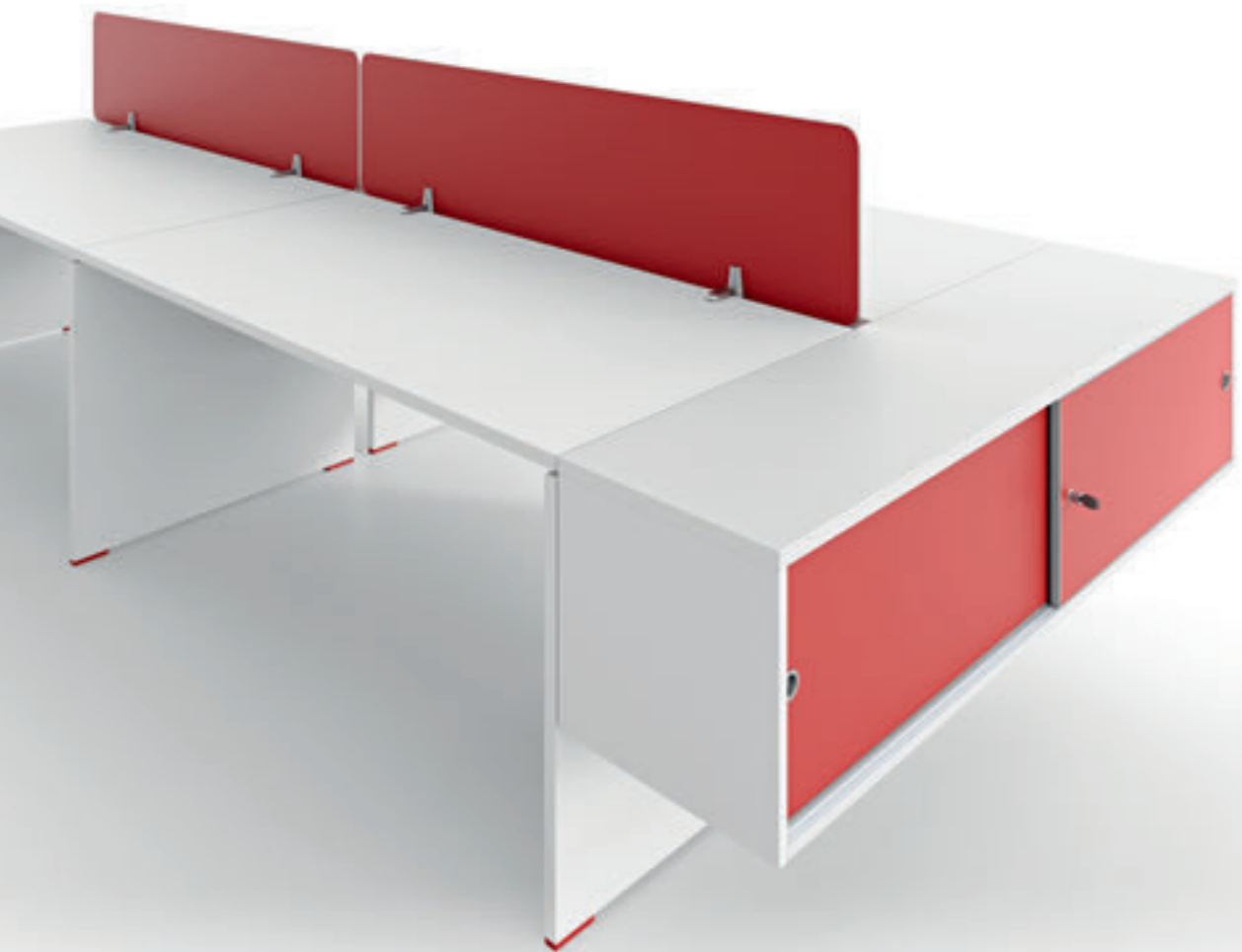

# DESIGN



Prospettive da manuale che mettono in evidenza la tradizionale scrivania pannellata rivista in chiave moderna. Ricercatezza dei dettagli e accurata scelta dei materiali fanno di questo sistema un punto di riferimento nell'arredo operativo.

Perspectives that emphasizes the traditional panelled leg desk, reviewed with a modern eye. Refinement of details and an accurate choice of materials make this system a reference point in the workstation furnishings.

# DV805 TREKO



# DV805 TREKO



Questa collezione utilizza le composizioni più svariate permettendo di progettare open space o spazi delimitati creando ambienti piacevoli ed accoglienti. In evidenza la sobrietà e l'eleganza ottenuta mescolando il bianco con il rovere tabacco.

This collection allows the design of endless compositions being it open spaces or defined areas, creating a pleasant and comfortable ambience. Evidence of sobriety and elegance, obtained by mixing white with tobacco oak.





Alternare lo spazio operativo con diverse soluzioni di arredo: singole con tavoli aggregati a mobili di servizio oppure composte con tavoli bench e piani terminali.

Alternation within the operative space through different furnishing solutions: single ones, with desks integrated to service units or composed ones, with bench tables and terminal tops.





DV805 TREKO



Configurazione composta con raccordi a 90°. Il tutto esaltato dalla leggerezza e modernità della finitura rovere chiaro abbinata ad esclusivi accessori di design.

Configuration composed with 90° connections. All enhanced by the lightness and modernity of the light oak finish, combined with exclusive designer accessories.



Tavolo riunioni ovale elegante e in sintonia con l'ambiente.

Oval conference table, stylish and in harmony with the environment.





# DV805 TREKO



Ambiente moderno e giocoso grazie anche alla particolarità dei vari complementi e al contesto architettonico. Bench composto da scrivanie affiancate in modo semplice e funzionale, in cui la nota di giallo dei frontal panel dona freschezza e luminosità tutt'intorno. In scena i sempre più richiesti "Standing-table" per il lavoro in piedi o seduti su sgabelli, in questo caso, di design ricercato.

Modern and playful environment thanks to the peculiarities of the various furnishing accessories and this architectural context. Bench configuration obtained by putting desks side by side in a simple and functional way, where the yellow tone of the frontal panels allows for freshness and brightness all around. In the spotlight the increasingly requested "Standing-tables" allowing to work in a standing or sitting position, in this case on stools of nice design.



In evidenza alcuni accessori molto utili e previsti per questo sistema, tra i quali il portadox in metallo e il porta CPU sospeso realizzato con semplici attacchi dotati di cinghie il cui montaggio sulla gamba risulta estremamente facile e rapido.

Vista aerea di grande impatto che descrive l'essenzialità e la pulizia del bench a quattro posti, con la boiserie sullo sfondo che valorizza e abbellisce lo spazio circostante. Stile ed eleganza grazie alla presenza dominante del rovere tabacco.

Highlight on some very useful accessories developed for this system, including the metal binder storage-boxes and hanging CPU holders carried out with simple attacks and straps whose fitting on the leg is extremely easy and quick.

Aerial view of great impact that describes the simplicity and cleanness of the four-seat-bench with decorative panelling (boiserie) in the background that enhances the beauty of the surrounding space. Style and elegance thanks to the dominant presence of tobacco oak.





Focus ravvicinato per evidenziare i dettagli degli "Standing tables" con poggiapiedi in acciaio inox satinato. Questi tavoli vengono usati sempre più spesso per svariate attività svolte negli ambienti di lavoro.

Close view to highlight the details of the "Standing tables" with footrest in brushed satin steel. These tables are being used increasingly for a variety of activities carried out in workplaces.



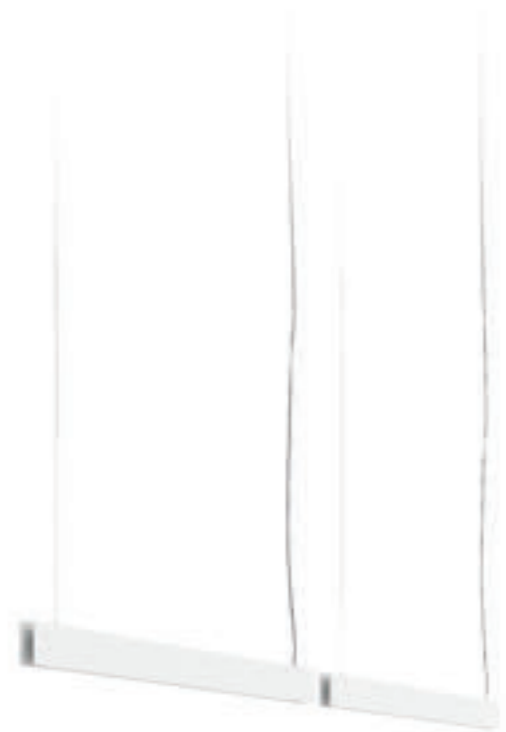

# DV805 TREKO



Molteplici sono le possibili soluzioni di bench e di postazioni individuali che, attraverso l'impiego di frontal panels colorati, contenitori sospesi e accessori permettono di personalizzare il posto di lavoro con la giusta privacy.

There are many possible bench and individual workstation solutions. Through the use of coloured frontal panels, hanging storage units and accessories they allow to customize the workstation with an appropriate privacy.



Bench composto da tavoli collegati in linea, corredati di gambe intermedie, cassettiere e contenitori terminali sospesi, nella versione a giorno e con ante scorrevoli. Fresco e di tendenza l'accostamento del bianco ai frontal panel in verde bambù.

Bench configuration consisting of in-line, linked desks equipped with intermediate legs, chests of drawers and hanging terminal storage units in both options: open and with sliding doors. Cool and trendy the combination of the white with bamboo-green frontal panels.





I diversi elementi della collezione permettono di comporre e creare con la massima libertà, generando svariate e appropriate soluzioni di arredo per ogni spazio di lavoro a disposizione. Qui a fianco, notiamo i tavoli con piani sagomati a onda che creano un'originale composizione.

All different elements of this collection allow to compose and create to the greatest possible extent, generating varied and appropriate furnishing solutions for every available working space. Here on the right, desks with wave-shaped tops create a very original composition.



DV805 TREKO



Esemplare configurazione destinata al lavoro di gruppo, ampie superfici attrezzate e personalizzate secondo le diverse mansioni da svolgere. In evidenza specifici accessori per l'informatica che si fondono perfettamente con lo stile accattivante conferitogli dal colore rosso.

Exemplary configuration intended for group work, large equipped surfaces, customized to fit different tasks. Highlight on specific accessories for computers that blend perfectly with the eye-catching style conferred by the colour red.



Primo piano sui dettagli caratterizzanti dei tavoli: in questo caso si abbina il grigio delle gambe con il rosso dei piedini e distanziali; il porta CPU su cinghie è molto utile anche in situazioni particolari in cui è presente la gamba intermedia.  
Ampia prospettiva aerea che valorizza e mette in evidenza i contenuti e l'estetica di questa collezione davvero "smart"!

Close up on the characterizing details of these desks: in this scene the gray panelled legs are combined with red feet and spacers; the CPU holder on straps is very useful also in special situations that include a middle leg.  
The extensive aerial perspective enhances and highlights the content and appearance of this really "smart" collection!





DV805 TREKO





Flessibilità e componibilità dei diversi elementi, permettono di comporre uffici su misura. La collezione è predisposta per mescolare e combinare, nelle diverse finiture, i componenti di uno stesso tavolo. Molto gradevole in questo caso la combinazione dei tavoli in rovere moro con i modesty panels in finitura bianca.

The flexibility and modularity of different elements, allow the composition of customized office spaces. This collection is designed to mix and match the different component finishes of a same table. Very pleasant, in this example, the combination of dark oak desks and the white finish of the modesty panels.





# DV805 TREKO



Sinuosità e curve ergonomiche emergono nella vista d'insieme di questa simpatica e vivace composizione creata con facilità, mescolando e integrando tavoli scrivanie con raccordi a 120° e penisole. Particolarmente brioso l'abbinamento dei colori bianco, grigio e giallo che trasmettono un reale senso di relax e benessere.

Sinuous and ergonomic curves emerge in the overall view of this lovely and lively composition created mixing and integrating tables desks with 120 ° connections and curved end tops. Particularly cheerful combination of the colours white, gray and yellow that convey a real sense of relaxation and "well-being".



Dinamicità e versatilità per questa composizione molto interessante nella forma e nell'impatto estetico; l'ambiente intorno è corredato da "Standing tables", un piccolo tavolo riunioni e librerie in diverse tipologie.

Dynamism and versatility in this composition, very attractive for its layout and esthetical impact; the surrounding environment is completed with "Standing tables", a small meeting table and storage units of different styles.





# DV805 TREKO



Ambiente di lavoro spazioso e luminoso all'insegna dell'essenzialità e della praticità, in cui gli elementi presenti arredano secondo i criteri dello stile tradizionale ma con un sapore moderno e attuale. Posti di lavoro indipendenti con l'ausilio di un ampio tavolo riunioni. Molto eleganti le librerie con ante scorrevoli in versione "total white".

Spacious and bright working environment, banner of essentiality and practicality, in which all items furnish according to a traditional style criteria, yet with a modern flavour. Individual workstations with the support of a large conference table. Very elegant bookshelves with sliding doors in a "total white" look.



In primo piano i dettagli dei diversi posti lavoro: scrivania singola o con allungo su cassettiera portante, tavolo riunioni con top access per i cablaggi e il doppio colore rovere moro abbinato al bianco delle gambe.

In the foreground the details of the different workstations: individual desk or including an extensions table on carrying pedestal, meeting table with top access for wire management and colour combination of dark oak with the white of the panelled legs.





9



DV805 TREKO



Materiali e colori che ricordano con forza lo stile nordico: il caldo rovere chiaro con l'azzurro turchese. Il tutto ben disposto all'insegna del comfort, in un open space progettato a regola d'arte. Tre aree destinate al lavoro individuale e di gruppo, quindi tre soluzioni compositive diverse e personalizzate grazie all'adattabilità degli elementi del sistema.

Materials and colours that remind with strength of the Nordic style: warm light oak with blue turquoise. Very well-displayed to allow for comfort, in an open space designed in a workmanlike manner. Three areas for individual and group work, so three different composition solutions, personalized thanks to the adaptability of all elements of this system.



Vista d'insieme del tavolo riunioni composto da scrivanie aggregate e raccordate da penisole terminali su colonne.  
 Qui a fianco: soluzione postazioni di lavoro attrezzate con frontal panel parziali e cassettiere portanti in finitura.

An overview of the meeting table composed of desks and terminal tops supported by metal columns. On the right: a workstation solution equipped with partial frontal panels and carrying pedestals to match.





# PLUS&DETAILS



Frontal panel in melaminico sp. 1 cm  
Frontal panels in melamine 1 cm thick



Accessori per "Frontal panel in melaminico"  
Accessories for "melamine frontal panels"



Porta CPU sospeso con cinghie - Hanging CPU holder with straps



Tappi passacavi - Outlet lids



Canale + vertebra passacavi - Cable channel and vertebra

# ELEMENTS

## ELEMENTS



Piani di lavoro in melaminico sp. 25 mm con bordi perimetrali in ABS / Worktops in melamine 25 mm thick with perimetrical edges in ABS

TAVOLI SCRIVANIA - DESKS

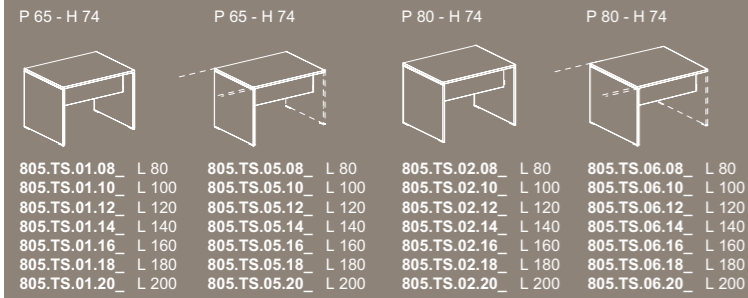

TAVOLO SCRIVANIA SAGOMATO - SHAPED DESK

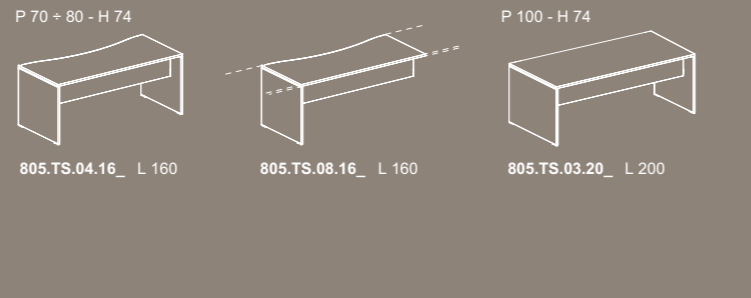

"STANDING TABLE" H 107

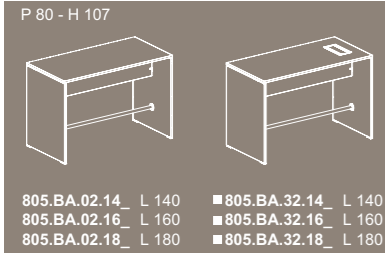

ALLUNGO LATERALE - LATERAL EXTENSION

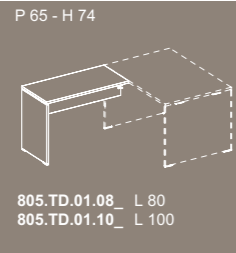

ALLUNGHI SU CASSETTIERE PORTANTI - EXTENSIONS ON CARRYING PEDESTALS

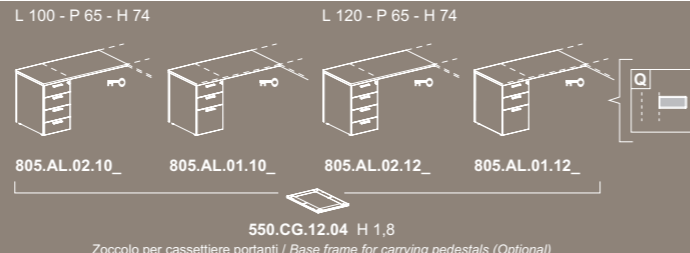

RACCORDI - CONNECTION ELEMENTS

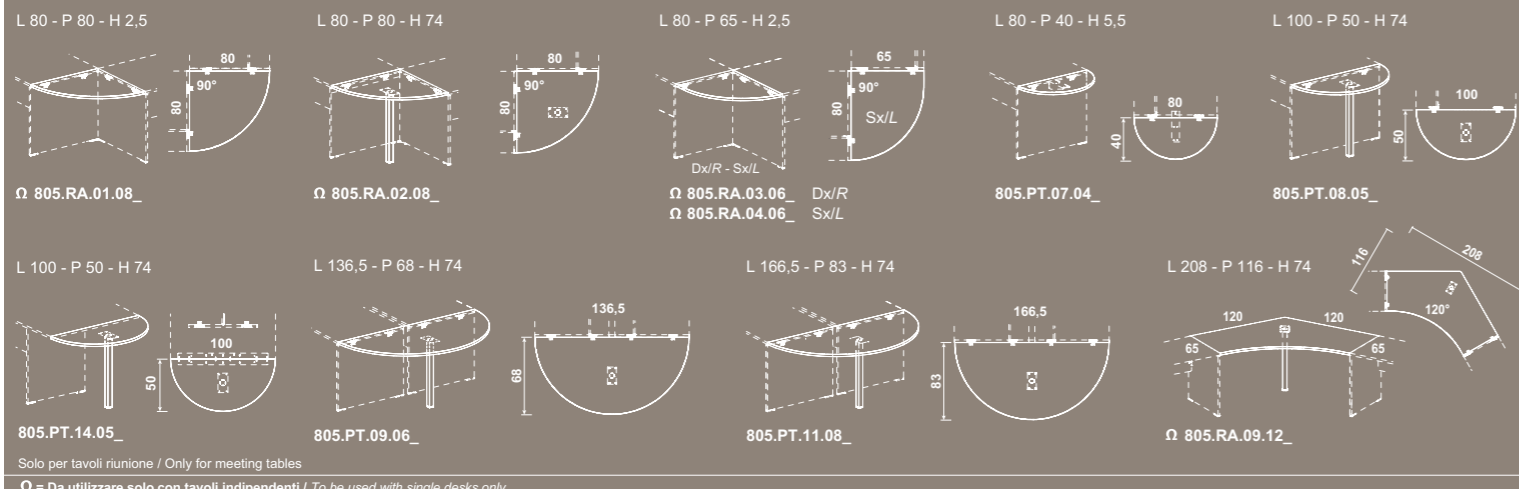

PIANI TERMINALI - TERMINAL TOPS

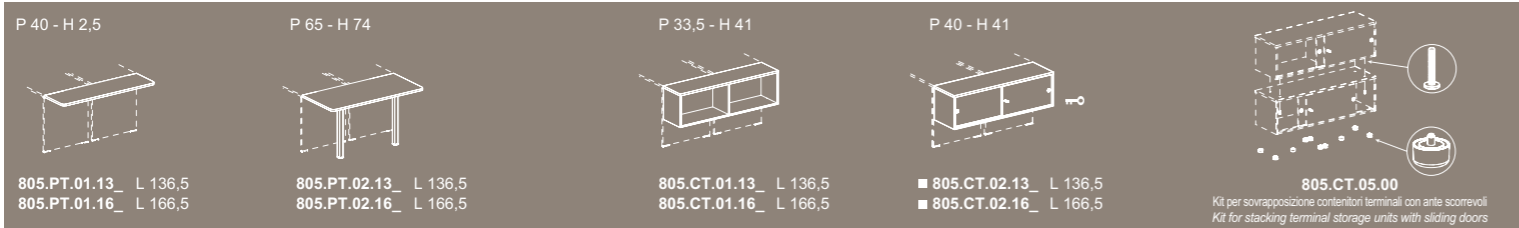

CONTENITORI TERMINALI A GIORNO E CON ANTE SCORREVOLI - OPEN TERMINAL STORAGE UNITS AND WITH SLIDING DOORS

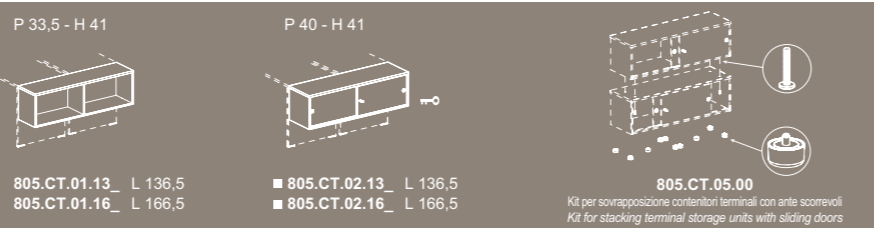

MOBILI DI SERVIZIO - SERVICE UNITS

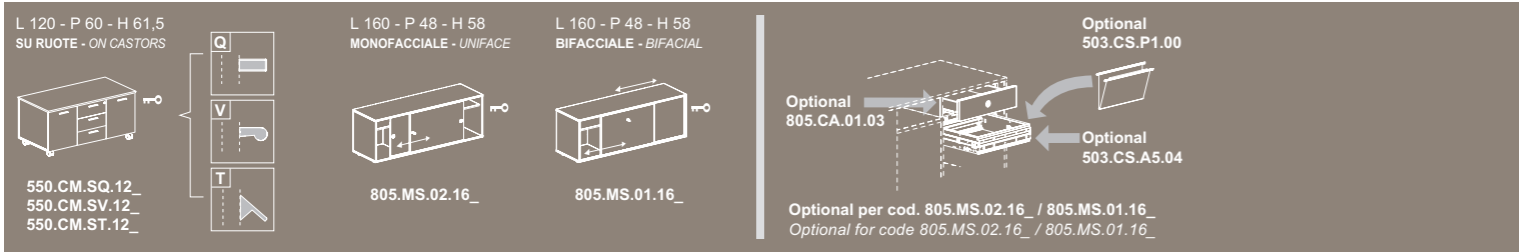

N.B. La finitura impiallacciato non è in pronta consegna. Per la disponibilità contattare l'ufficio commerciale / Note: Veneered finish is not in prompt delivery. Please contact the commercial department to check availability.  
 ■ = Prodotti non in pronta consegna. Per la disponibilità contattare l'ufficio commerciale / Items not in prompt delivery. Please contact the commercial department to check availability. → Con serratura / With lock  
**N.B.: LE DIMENSIONI SONO ESPRESSE IN CM - CONSULTARE IL LISTINO PREZZI PER LE CARATTERISTICHE TECNICHE, I CODICI DEGLI ARTICOLI E DELLE FINITURE.**  
 N.B.: DIMENSIONS ARE STATED IN CM - FOR TECHNICAL CHARACTERISTICS, ARTICLE CODE NUMBERS AND FINISHING SEE PRICE LIST.

Piani di lavoro in melaminico sp. 25 mm con bordi perimetrali in ABS / Worktops in melamine 25 mm thick with perimetrical edges in ABS

CASSETTIERE PORTANTI - CARRYING PEDESTALS

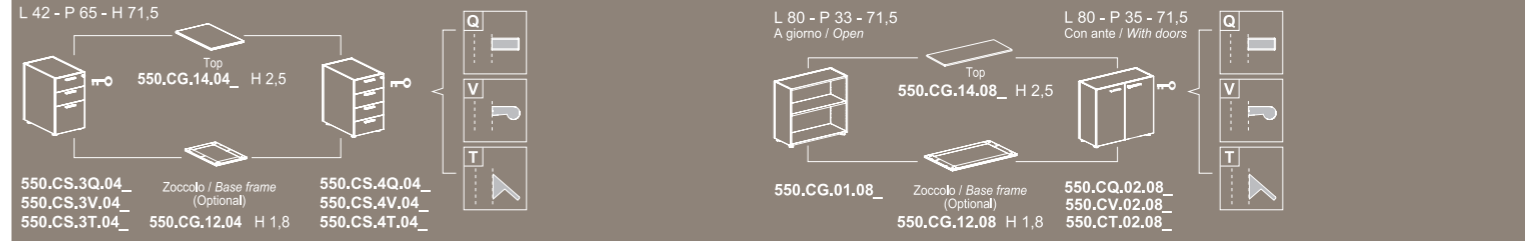

CONTENITORI H. 74 - STORAGE UNITS H. 74

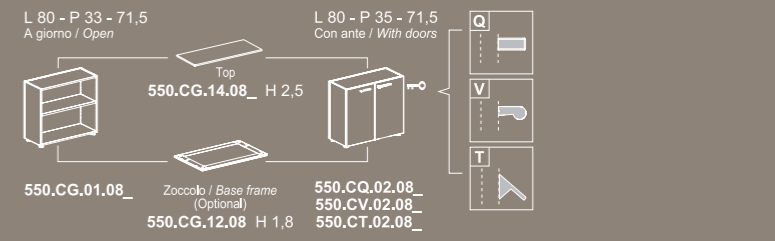

CASSETTIERE - PEDESTALS

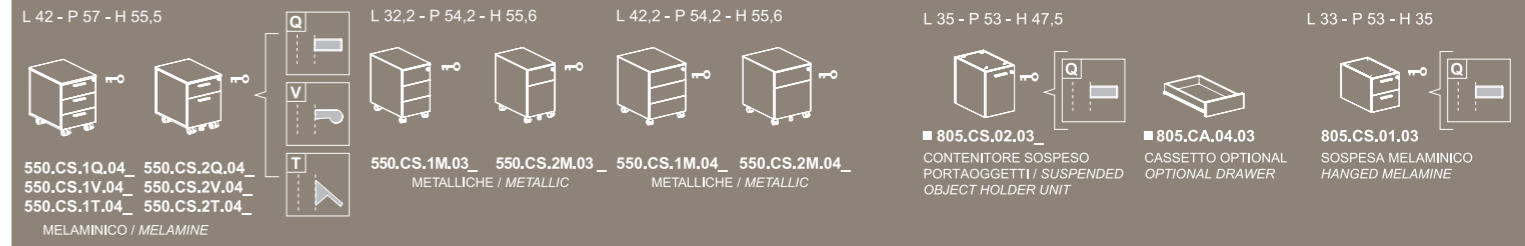

N.B. La finitura impiallacciato non è in pronta consegna. Per la disponibilità contattare l'ufficio commerciale / Note: Veneered finish is not in prompt delivery. Please contact the commercial department to check availability.  
 N.B. Per portacancelleria cassetti, vedi capitolo DV300-Accessori / Note: For stationary tray, see chapter DV300-Accessories. → Con serratura / With lock

TAVOLI RIUNIONI - CONFERENCE TABLES

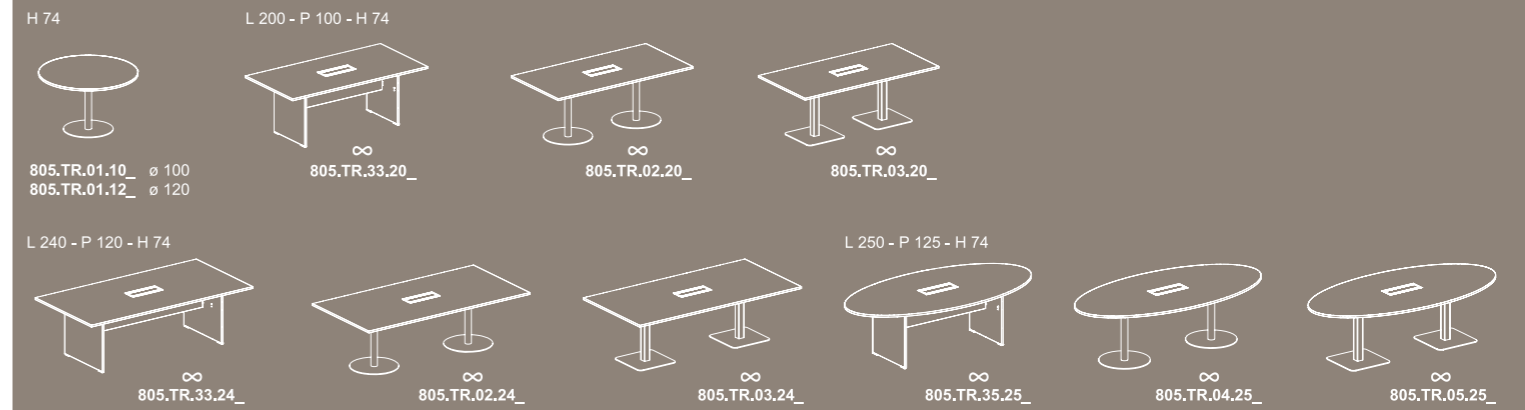

MORSETTI E SUPPORTI CONICI PER FRONTAL PANELS SP. 1 - SP. 0,8 - CLAMPS AND CONIC CLAMPS FOR FRONTAL PANELS T. 1 - T. 0,8

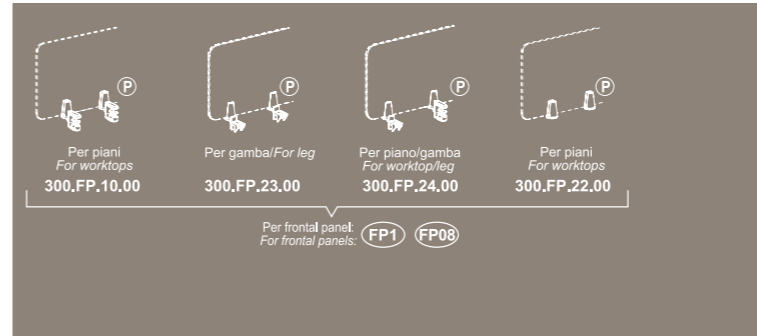

FRONTAL PANELS SP. 1 - SP. 0,8

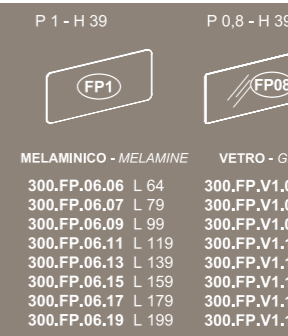

FRONTAL PANEL IN TESSUTO SP. 3 - FABRIC FRONTAL PANELS T. 3

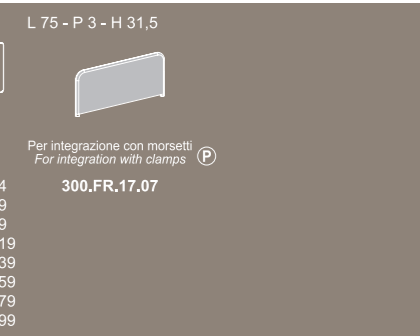

MORSETTI E SUPPORTI CONICI PER FRONTAL PANELS IN MELAMINICO SP. 3 - CLAMPS AND CONIC CLAMPS FOR MELAMINE FRONTAL PANELS T. 3

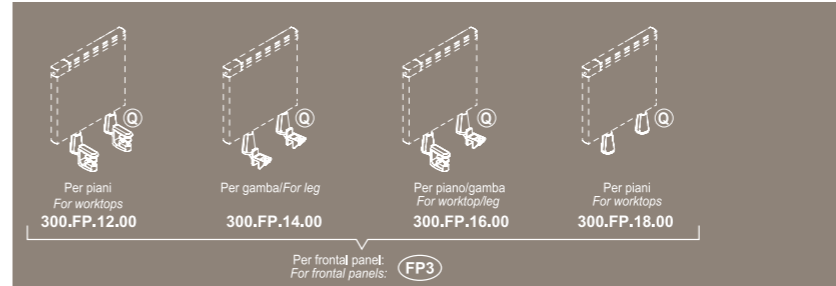

FRONTAL PANEL IN MELAMINICO SP. 3 - MELAMINE FRONTAL PANELS T. 3

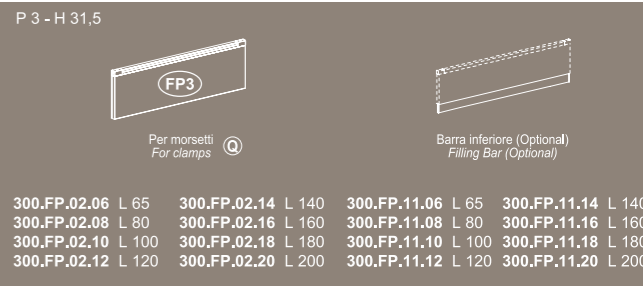

○ = Per eventuali giacenze a magazzino delle precedenti versioni senza top-access, contattare l'ufficio commerciale / To check stock availabilities of table tops without top-access, please contact our commercial department.  
 ■ = Prodotti non in pronta consegna. Per la disponibilità contattare l'ufficio commerciale / Items not in prompt delivery. Please contact the commercial department to check availability.  
**N.B.: LE DIMENSIONI SONO ESPRESSE IN CM - CONSULTARE IL LISTINO PREZZI PER LE CARATTERISTICHE TECNICHE, I CODICI DEGLI ARTICOLI E DELLE FINITURE.**  
 N.B.: DIMENSIONS ARE STATED IN CM - FOR TECHNICAL CHARACTERISTICS, ARTICLE CODE NUMBERS AND FINISHING SEE PRICE LIST. → Con serratura / With lock

## FRONTAL PANELS IN TESSUTO CON MORSETTI INTEGRATI - FABRIC FRONTAL PANELS WITH CLAMPS

L 120 - P 1,8 - H 40	L 120 - P 1,8 - H 88	P 4 - H 59	
Per piani/For worktops	Per piani/For worktops	Per piani/For worktops	Per piani/For worktops
300.FP.04.12	300.FP.08.12	300.FP.07.12	■ 300.FR.07.14 L 140 ■ 300.FR.07.16 L 160

## ACCESSORI PER FRONTAL PANELS IN MELAMINICO - ACCESSORIES FOR MELAMINE FRONTAL PANELS

L 6,5 - P 6,5 - H 8,5	L 50 - P 17 - H 3	L 34 - P 23 - H 23	L 27 - P 22 - H 22	L 12 - P 22 - H 28	L 23 - P 31 - H 5	L 31 - P 22 - H 5	L 23 - P 10 - H 29	L 35 - P 6,5 - H 30	L 18 - P 13 - H 12
300.FA.01.01	300.FA.02.05	300.FA.03.03	300.FA.05.02	300.FA.05.01	300.FA.04.02	300.FA.04.03	300.FA.06.02	300.FA.08.03	300.FA.07.01

N.B. - NOTES: Il posizionamento degli accessori sui frontal panel in vetro prevede l'utilizzo di una guarnizione in PVC trasparente (Optional su richiesta) / Placement of accessories on glass front panel need the use of a transparent PVC gasket (Optional on request)

## CANALIZZAZIONE / ELETRIFICAZIONE / ACCESSORI - WIRE - MANAGEMENT / ELECTRIFICATION / ACCESSORIES

805.CL.01.40	805.AP.32.01 Per "standing tables" H 107 con top access For H 107 "standing tables" with top access	300.AP.V1.00	300.AP.F1.00	300.AP.T2.01 ø 8	300.AP.T7.01 ø 6	300.AP.T8.01 ø 8	300.AP.C1.00
300.AC.26.02 L 24,5 300.AC.26.03 L 34,5 300.AC.26.04 L 44,5	Per/For top access 300.AC.26... (*) ■ 300.AP.S1.02 L 20,5 ■ 300.AP.S1.03 L 30 ■ 300.AP.S1.04 L 42	■ 300.AT.A1.02 L 22 ■ 300.AT.A1.03 L 31,5 ■ 300.AT.A1.04 L 43,5	300.AP.S4.00 ● 300.AP.S5.00 UK ● 300.AP.S6.00 US	300.AP.S1.00 ● 300.AP.S2.00 UK ● 300.AP.S3.00 US	300.AP.B1.04 ● 300.AP.B2.04 UK ● 300.AP.B3.04 US	300.AP.T4.01 ● 300.AP.T5.01 UK ● 300.AP.T6.01 US	● 300.AP.C2.00 UK ● 300.AP.C3.00 US
805.AC.01.00	300.AC.06.05	300.AC.10.00 Braccio porta video per piano singolo Arm for video support for single desk	300.AC.12.00 Braccio porta video per piani contrapposti Arm for video support for bench	805.KT.01.00 Kit per 2 gambe tavoli (Optional) Kit for 2 table legs (Optional)	805.KT.02.00 Kit per 1 gamba intermedia tavoli (Optional) Kit for 1 table middle leg (Optional)		

● = Articoli prodotti solo su richiesta / Items produced only on demand ■ = Prodotti non in pronta consegna. Per la disponibilità contattare l'ufficio commerciale / Items not in prompt delivery. Please contact the commercial department to check availability  
 NOTA BENE - NOTES: Per la scelta dei contenitori e degli accessori vari, consultare il relativo listino o catalogo / To choose storage units and accessories, please check correspondent price list or catalogue

N.B.: LE DIMENSIONI SONO ESPRESSE IN CM - CONSULTARE IL LISTINO PREZZI PER LE CARATTERISTICHE TECNICHE, I CODICI DEGLI ARTICOLI E DELLE FINITURE.  
 N.B.: DIMENSIONS ARE STATED IN CM - FOR TECHNICAL CHARACTERISTICS, ARTICLE CODE NUMBERS AND FINISHING SEE PRICE LIST.

Finiture cromatiche Accessori/Accessories colour finishes

FRONTAL PANELS IN MELAMINICO MELAMINE FRONTAL PANELS

Frontal panels sp. 1 cm, in melaminico con bordo ABS sp. 0.15 cm colore alluminio  
Frontal panels 1 cm thick, in melamine with aluminium-coloured ABS edge-profile 0.15 cm thick

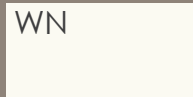

Bianco  
White



Alluminio  
Aluminium

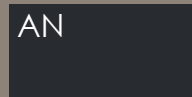

Antracite  
Anthracite

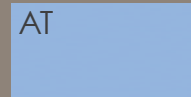

Azzurro turchese  
Turquoise blue



Giallo senape  
Mustard yellow

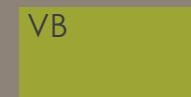

Verde bambu'  
Bamboo green



Rosso papavero  
Poppy red

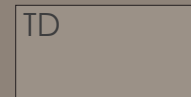

Terra d'ombra  
Umber

Frontal panels sp. 3 cm, in melaminico con bordi in ABS verticali sp. 0.45 cm e orizzontale inferiore sp. 0.2 cm  
Frontal panels 3 cm thick, in melamine. The ABS vertical edges are convex shaped 0.45 mm thick, while the horizontal lower edge is made of ABS 0.2 cm

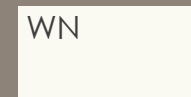

Bianco  
White

FRONTAL PANELS IN VETRO GLASS FRONTAL PANELS

Frontal panels sp. 0.8 cm, in vetro stratificato  
Frontal panels 0.8 cm thick, stratified glass



Bianco  
White



Verde  
Green

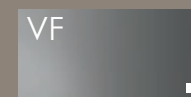

Fumé  
Smoked grey glass

FRONTAL PANELS (\*) E CUSCINI (\*\*) IN TESSUTO FABRIC FRONTAL PANELS(\*) AND CUSHION (\*\*)

100% Lana - 100% Wool

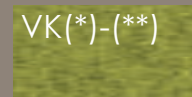

Verde Kiwi  
Kiwi green

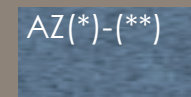

Azzurro cielo  
Blue sky

100% Lana "Soft" - 100% "Soft" Wool

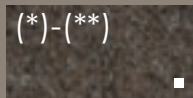

Marrone SOFT403  
Brown SOFT403

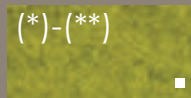

Verde SOFT510  
Green SOFT510

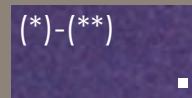

Viola SOFT003  
Violet SOFT003

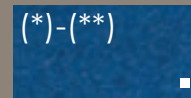

Azzurro SOFT700  
Blue SOFT700

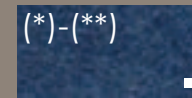

Blu SOFT701  
Blue SOFT701

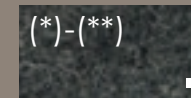

Antracite SOFT200  
Anthracite SOFT200

100% Poliestere Elastico  
100% Elastic Polyester

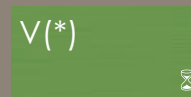

Verde  
Green

100% Poliestere "Trevira CS"  
100% Polyester "Trevira CS"

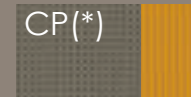

Cocco/Papaya  
Cocconu/Papaya

100% Poliestere - 100% Polyester



Rosso Bom33  
Red Bom33



Grigio Bom56  
Grey Bom56



Blu Bom37  
Blue Bom37



Verde Bom48  
Green Bom48



TAVOLI TABLES

Piani di lavoro, gambe pannellate sp. 2.5 cm con bordi in ABS sp. 0.2 cm e modesty panels sp. 1.8 cm in melaminico  
Worktops and panelled legs 2.5 cm thick with 0.2 cm thick ABS edgebanding, modesty panels 1.8 cm thick, in melamine

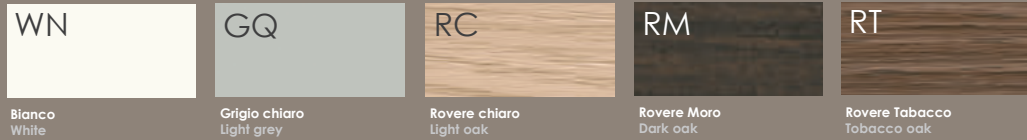

Bianco  
White

Grigio chiaro  
Light grey

Rovere chiaro  
Light oak

Rovere Moro  
Dark oak

Rovere Tabacco  
Tobacco oak

COMPONENTI IN METALLO METAL COMPONENTS

Gamboni /colonne in metallo Metal columns

Poggiapiedi in tubo Footrest tube

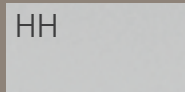

Alluminio  
Aluminium

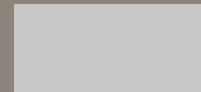

Acciaio inox satinato  
Satin steel

FRONTAL PANELS IN MELAMINICO MELAMINE FRONTAL PANELS

Frontal panel in melaminico sp. 1 cm con bordo ABS sp. 0.15 cm colore alluminio  
Melamine frontal panels 1 cm thick with aluminium-coloured ABS edge-profile 0.15 cm thick

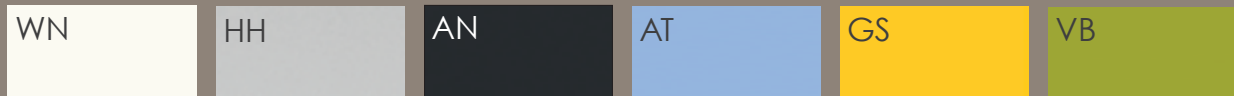

Bianco  
White

Alluminio  
Aluminium

Antracite  
Anthracite

Azzurro turchese  
Turquoise blue

Giallo senape  
Mustard yellow

Verde bambu'  
Bamboo green



Rosso papavero  
Poppy red

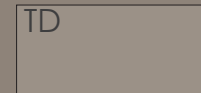

Terra d'ombra  
Umber

MOBILI DI SERVIZIO E CONTENITORI TERMINALI SERVICE UNITS AND TERMINAL STORAGE UNITS

Scocca e ripiani in melaminico sp. 1.8 cm  
Bodies and shelves in melamine 1.8 cm thick



Bianco  
White

Alluminio  
Aluminium

Ante scorrevoli in melaminico sp. 1.8 cm con bordo ABS sp. 0.15 cm colore alluminio  
Melamine sliding doors 1.8 cm thick with aluminium-coloured ABS edge-profiles 0.15 cm thick



Bianco  
White

Azzurro turchese  
Turquoise blue

Giallo senape  
Mustard yellow

Verde bambu'  
Bamboo green

Rosso papavero  
Poppy red

Terra d'ombra  
Umber

PIEDINI LIVELLATORI E DISTANZIALI IN ABS ADJUSTABLE FEET AND ABS SPACERS

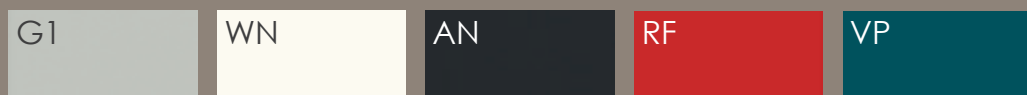

Grigio (Standard)  
Grey

Bianco (Optional)  
White

Antracite (Optional)  
Anthracite

Rosso fuoco (Optional)  
Fire red

Verde petrolio (Optional)  
Oil green



Della Valentina Office s.p.a. - Azienda Certificata / Certified Company



C/DV80502

Solo i prodotti identificati come tali sono certificati FSC®  
Only the products identified as FSC® are certified as such

## < COLOUR FINISHES

### industrial design

Antonio Morello

### art direction

DriussoAssociati | Architects

### virtual set design

DriussoAssociati | Architects

### graphic design

DA | A

### production image

NeroKubo

**CONTRA**  
Rete d'impresa

Printed in Italy by  
Sincromia

Issue 02 - May 16



### thanks to

Adesso  
Arflex  
Arper  
Artemide  
Axo Light  
B&B  
Belux  
Delightfull  
Estiluz  
Flos  
Gandia Blasco  
Interstuhl  
Karboxx  
Kartel  
Kastel  
Lasvit  
Ligne Roset  
Louis Poulsen  
Luceplan  
Moooli  
Moroso  
Niche Modern  
Offecct  
Poliform  
Sancal  
Vicarbe Habitat

Foto e testi copyright DVO non riproducibili.

La venditrice si riserva la facoltà di apportare al prodotto eventuali modifiche tecniche, dimensionali ed estetiche in qualsiasi momento senza preavviso.

Pictures and text are DVO copyright, duplicate forbidden.

The selling Company reserves the right to introduce changes to products regarding sizes and aesthetical or technical aspects at any time without notice.



**DVO**<sup>®</sup>  
DELLA VALENTINA OFFICE

Della Valentina Office s.p.a.  
Via XX Settembre, 272  
Casella Postale n. 65  
U.P. Roveredo in Piano  
33080 Roveredo in Piano (PN) Italy

Tel. +39 0434 386 111  
Fax +39 0434 386 112  
[www.dvoffice.com](http://www.dvoffice.com)  
[dvo@dvoffice.com](mailto:dvo@dvoffice.com)