

dvo_



Finiture / Finishings

TAVOLI / FIANCHI TERMINALI E TOP CONTENITORI TABLES / TERMINAL SIDE PANELS AND STORAGE UNIT TOPS

Piani di lavoro, gambe, fianchi terminali e Top sp. 6 cm, in laccato lucido (*) o impiallacciato (**)
Worktops, legs, terminal side panels and tops are 6 cm thick, in high gloss lacquer (*) or veneered finish (**)

Bianco White	Panna Cream	Verde Green	Blu Blue	Rosso Red	Nero Black
		Noce Walnut	Ebano Ebony	Rovere chiaro Light oak	Rovere scuro Dark oak

CASSETTIERE / MOBILI DI SERVIZIO / MADIE PEDESTALS / SERVICE UNITS / SIDEBARDS

Scocche, ripiani sp. 2.5 cm e ante, frontali sp. 6 cm in laccato lucido (*) o impiallacciato (**)
2.5 cm thick bodies and shelves, 6 cm thick doors and drawer fronts, in high gloss lacquer (*) or veneered finish (**)

Bianco White	Panna Cream	Verde Green	Blu Blue	Rosso Red	Nero Black
		Noce Walnut	Ebano Ebony	Rovere chiaro Light oak	Rovere scuro Dark oak

BOISERIE

Pannelli sp. 2.5 cm e mensole sp. 6 cm in laccato lucido (*) o impiallacciato (**)
2.5 cm thick panels, 6 cm thick shelves, in high gloss lacquer (*) or veneered finish (**)

Bianco White	Panna Cream	Verde Green	Blu Blue	Rosso Red	Nero Black
		Noce Walnut	Ebano Ebony	Rovere chiaro Light oak	Rovere scuro Dark oak

Della Valentina Office s.p.a. - Azienda Certificata / Certified Company



Solo i prodotti identificati come tali sono certificati FSC.
Only the products identified as FSC are certified as such



C/DV90701



DV907

Design by
Ludovica+Roberto Palomba

DV900 EXECUTIVE

Century

DV907 / Century

Configuration Systems:



**Una scelta di classe che
esprime autorevolezza,
solidità, eleganza.**

**Per chi ama la linearità e
la semplicità e sa definire
intorno a sé un ambiente
ricercato ma rigoroso.**

A choice of class expressing
authority, strength, elegance.
For those who love simplicity
and linearity, and know how
to define a sophisticated
but rigorous environment
around them.

1. p. 4

2. p. 8



3. p. 10

4. p. 14

5. p. 18



Configurazione
Configuration

1



Semplicità ricercata nelle calde sfumature del legno. Scrivania integrata con mobile di servizio e modesty panel completata da boiserie e madia con anta scorrevole. L'abbinamento del legno in finitura rovere chiaro e il laccato lucido colore panna, esaltano la bellezza della collezione.

Simplicity sought in the warm shades of wood. Integrated desk with service unit and modesty panel, completed with a boiserie and sideboard with sliding door. The combination of wood in light oak finish and high gloss cream colour lacquer, enhance the beauty of the collection.







Configurazione
Configuration

2

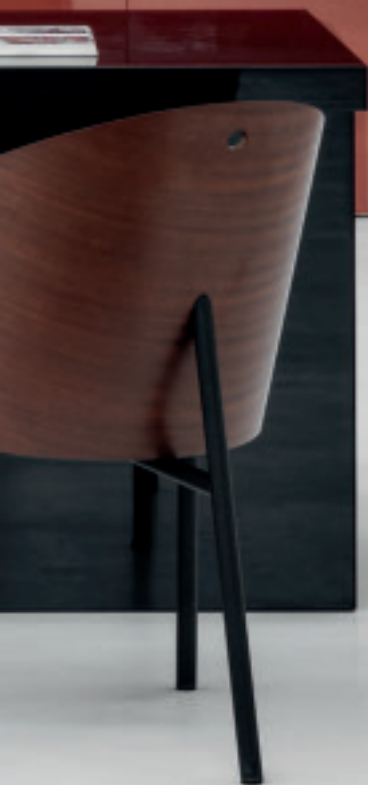

Uno stile moderno dal sapore tradizionale. Doppia boiserie in laccato lucido colore rosso con scrivania di ampie dimensioni integrata al modesty panel, il tutto in laccato lucido colore nero. L'ambiente è completato da un piccolo tavolo caffè e da contenitori bassi con ante battenti in laccato lucido colore rosso.

A modern style with a touch of tradition. Double red high gloss lacquered boiserie with a large desk with built-in modesty panel, all black high gloss lacquered. The environment is completed with a small coffee table and low cabinets with red high gloss lacquered, hinged doors.



Configurazione
Configuration

3



Accoglienza e comfort per riunirsi, confrontarsi e decidere. Ampio tavolo riunione in legno finitura ebano, abbinato a boiserie con madia in laccato lucido colore blu.

Hospitality and comfort for meeting, discussing and deciding. Large wooden conference table in ebony finish, combined with a boiserie and a blue high gloss lacquered sideboard.







Configurazione
Configuration

4

Suggestiva linearità compositiva. Posto lavoro che comprende: scrivania con 4 gambe, allungo integrato e modesty panel in legno, finitura rovere moro. Lo spazio circostante è corredato da contenitori con ante battenti della stessa finitura della scrivania e da un pratico tavolo riunione circolare in laccato lucido colore verde.

Striking compositional linearity workplace comprising: desk with 4 legs, integrated with an extension table and modesty panel in dark oak wood finish. The surrounding space is equipped with cabinets with hinged doors of the same finishing of the desk and with a practical green high gloss lacquered, round meeting table.





Focus su alcuni dettagli caratterizzanti: maniglia cromata e top access su piano di lavoro. A lato, primo piano per il tavolo riunione circolare; in evidenza la gamba canalizzata per il passaggio dei cablaggi.

Focus on some characterizing details such as: chromed handles and top access on the worktop. Beside, a close-up on the circular conference table; in evidence the channeled leg for wire management.



Configurazione
Configuration

5



Rigorous forms in harmony in a prestigious and elegant environment. Importance, comfort and functionality are the characteristics of this composition at the top of the range that unites the precious high gloss lacquered red color of the boiserie and the desk with the elegance of the Canaletto walnut wood finish of the service unit and sideboard.

Rigorous forms in harmony with the prestigious and elegant environment. Relevance, comfort and functionality; these are the characterizing elements of this composition at the top of the range, combining the precious red high gloss lacquered finishes of the boiserie and the desk, with the elegance of the Canaletto walnut wood finish of the service unit and sideboard.



Elements

tavoli scrivania / desks

L 200 - P 100 - H 75

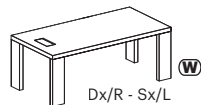

Dx/R - Sx/L

L 220 - P 100 - H 75

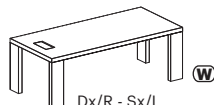

Dx/R - Sx/L

L 240 - P 100 - H 75

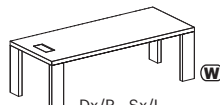

Dx/R - Sx/L

modesty panels

P 6,9 - H 45



L 100 - L120
L140 (per tavoli / for desks L 200)
L160 (per tavoli / for desks L 220-240)

(W) Nei tavoli scrivania una delle 4 gambe possiede un sistema di canalizzazione. In fase di montaggio è possibile scegliere dove posizionala. / Note: One of the four legs on each desk has a cable management system. During assembly of the table, it is possible to choose its position.

tavoli e allunghi dattilo / typing and extension tables

L 120 - P 65 - H 75

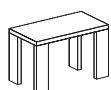

L 200 - P 65 - H 75

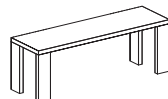

L 120 - P 65 - H 75

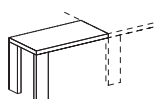

L 200 - P 65 - H 75

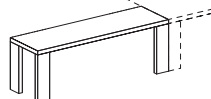

L 120 - P 65 - H 75

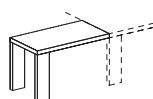

L 200 - P 65 - H 75

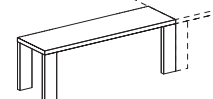

tavoli riunione / meeting tables

L 240 - P 120 - H 75

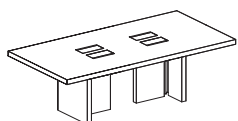

L 300 - P 120 - H 75

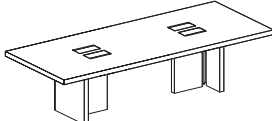

Ø 140 - H 75

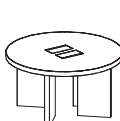

L 140 - P 140 - H 75

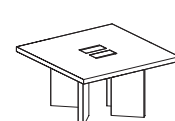

mobili di servizio e cassetteria interna / service unit and internal drawer

L 200 - P 70 - H 59

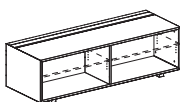

L 200 - P 100 - H 59

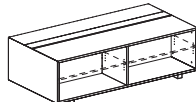

L 96 - P 50 - H 1,8



Ripiano per mobile di servizio /
Shelf for service unit

L 100 - P 54 - H 52

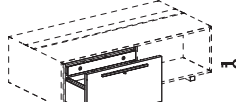

Cassetteria con un cassetto classificatore
più cassetto interno per mobile di servizio P 70 - 100 /
Pedestal for D.70-100 service unit with one filing
drawer and one internal drawer.

L 100 - P 54 - H 52

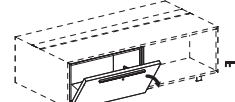

Anta a ribalta per mobile di servizio P 70 - 100 /
Drop down door for D70-100 service unit.

Indipendenti e per integrazione / Free-standing or to be integrated

Conserratura / With lock

tavoli integrabili con mobile di servizio / desk for integration with service units

L 200 - P 100 - H 75

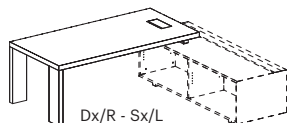

Dx/R - Sx/L

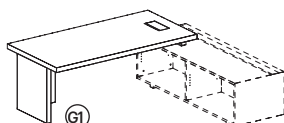

Dx/R - Sx/L

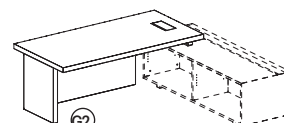

Dx/R - Sx/L

L 220 - P 100 - H 75

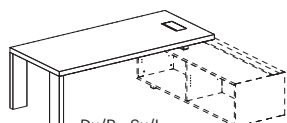

Dx/R - Sx/L

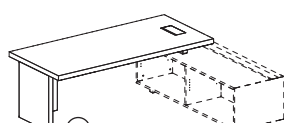

Dx/R - Sx/L

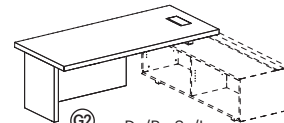

Dx/R - Sx/L

L 240 - P 120 - H 75

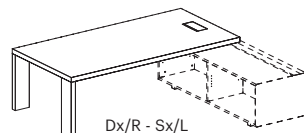

Dx/R - Sx/L

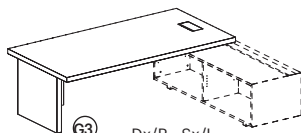

Dx/R - Sx/L

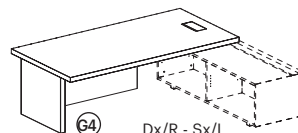

Dx/R - Sx/L

G1 Tavolo con gamba a "L" 60X50 / Desk with "L" shaped leg 60X50

G3 Tavolo con gamba a "L" 80X70 / Desk with "L" shaped leg 80X70

G2 Tavolo con gamba a "L" 60X140 / Desk with "L" shaped leg 60X140

G4 Tavolo con gamba a "L" 80X160 / Desk with "L" shaped leg 80X160

Elements

tavoli scrivania L 200 con mobile di servizio P 70 (Dx/Sx) / desks L 200 with service unit D 70 (R/L)

L = L1/L2 - P 227 - H 75

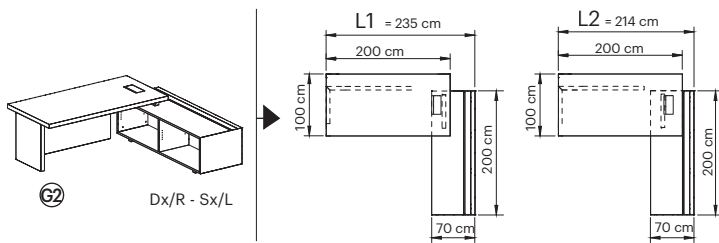
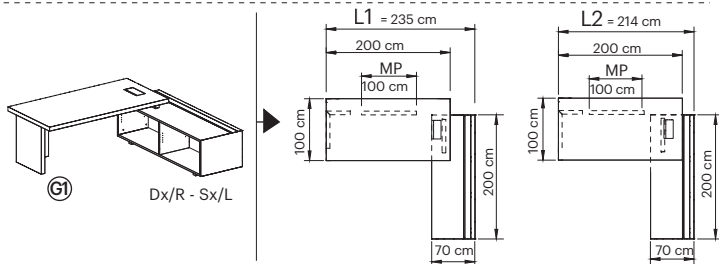
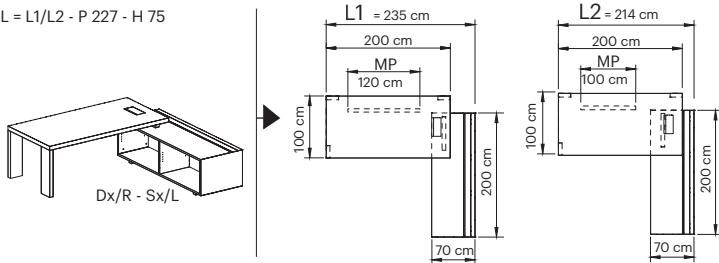

tavoli scrivania L 200 con mobile di servizio P 100 (Dx/Sx) / desks L 200 with service unit D 100 (R/L)

L = L3/L4 - P 227 - H 75

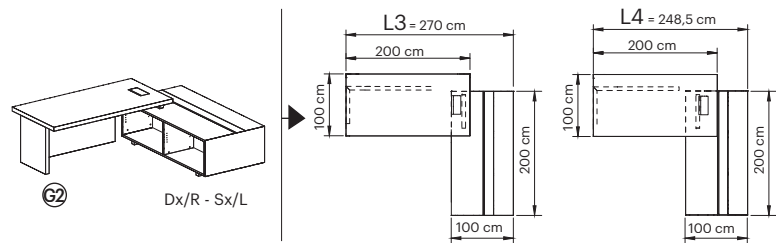
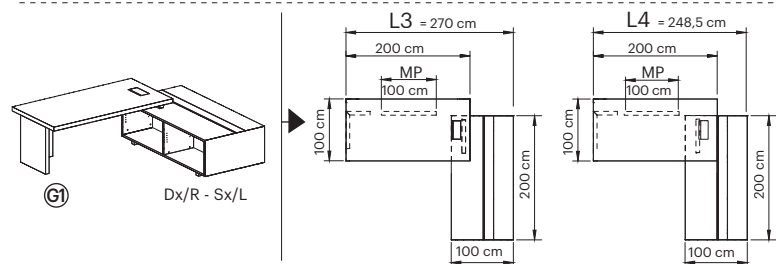
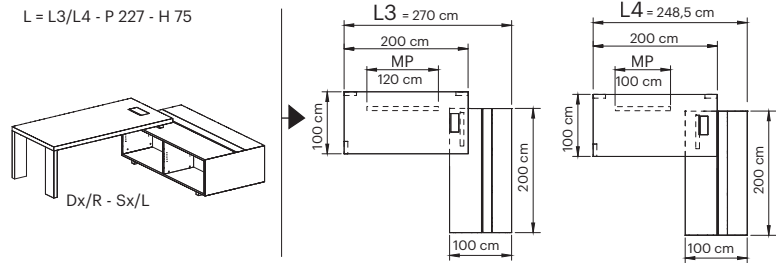

tavoli scrivania L 220 con mobile di servizio P 70 (Dx/Sx) / desks L 220 with service unit D 70 (R/L)

L = L5/L6 - P 227 - H 75

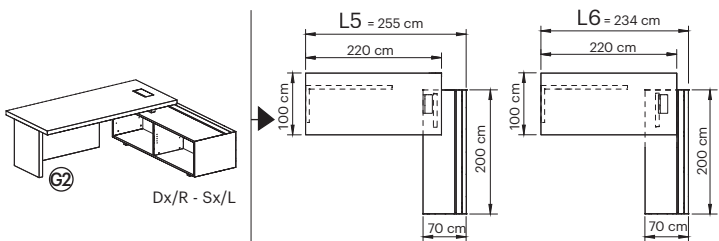
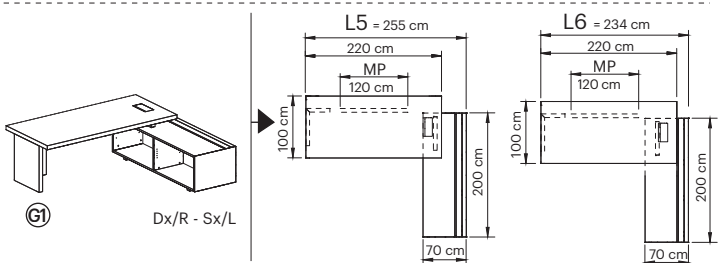
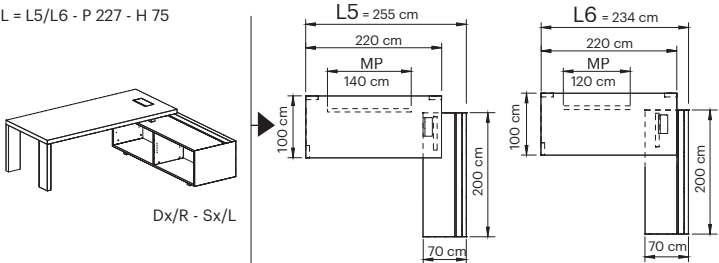

tavoli scrivania L 220 con mobile di servizio P 100 (Dx/Sx) / desks L 220 with service unit D 100 (R/L)

L = L7/L8 - P 227 - H 75

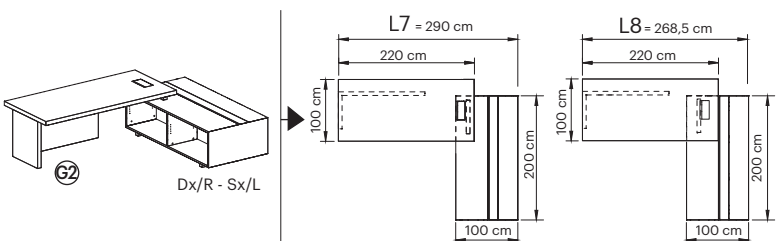
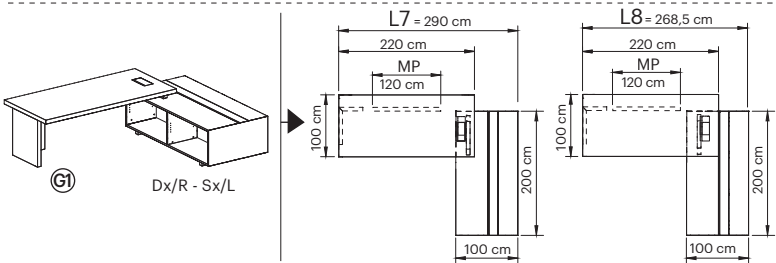
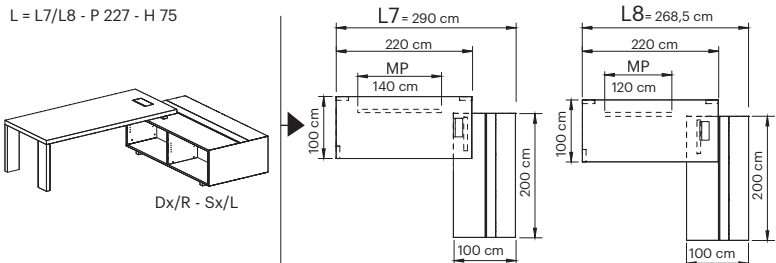

G1 Tavolo con gamba a "L" 60X50 / Desk with "L" shaped leg 60X50

G2 Tavolo con gamba a "L" 60X140 / Desk with "L" shaped leg 60X140

N.B.: I tavoli possono essere montati sui mobili di servizio (destri o sinistri) scegliendo tra 2 diverse posizioni. Per ogni soluzione compositiva è disponibile la dimensione del corrispondente modesty panel (vedi relativa quota indicata con MP) / Desks can be positioned on service units (right or left hand) in 2 different positions. Find the proper modesty panel to match the chosen composition (see sizes indicated with MP).

Elements

tavoli scrivania L 240 con mobile di servizio P 70 (Dx/Sx) / desks L 240 with service unit D 70 (R/L)

L = L9/L10 - P 227 - H 75

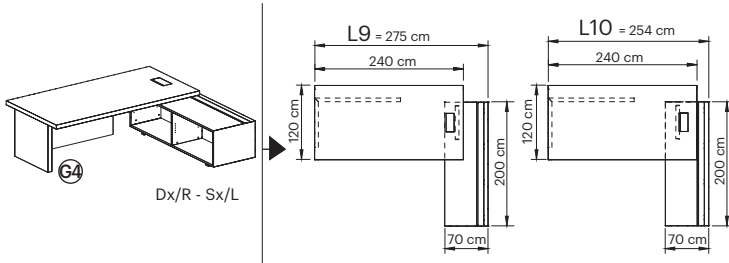
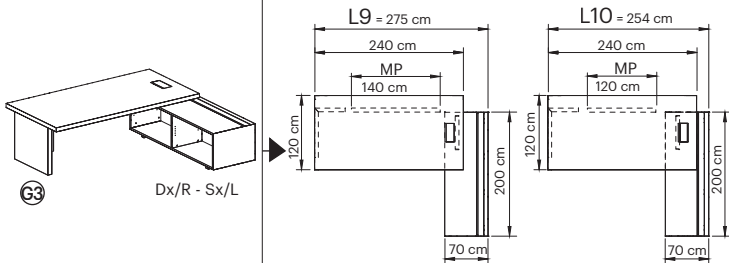
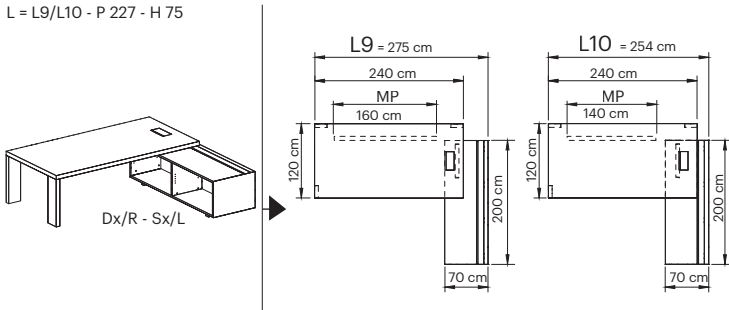

tavoli scrivania L 240 con mobile di servizio P 100 (Dx/Sx) / desks L 240 with service unit D 100 (R/L)

L = L11/L12 - P 227 - H 75

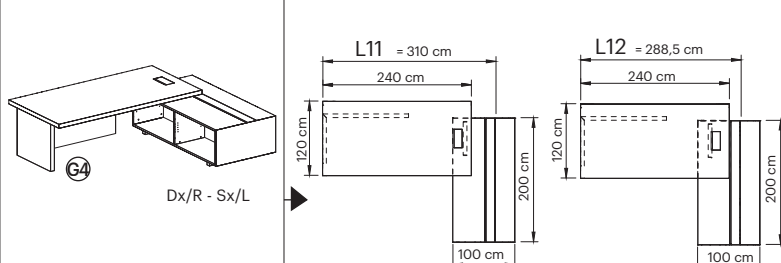
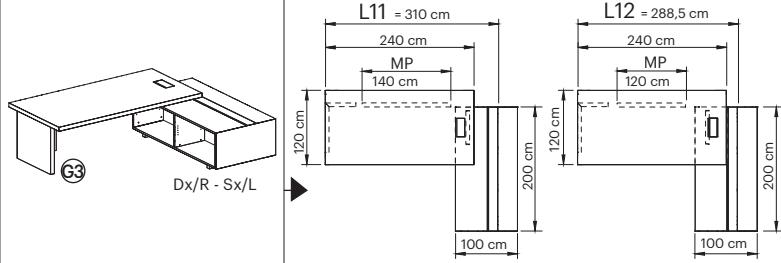
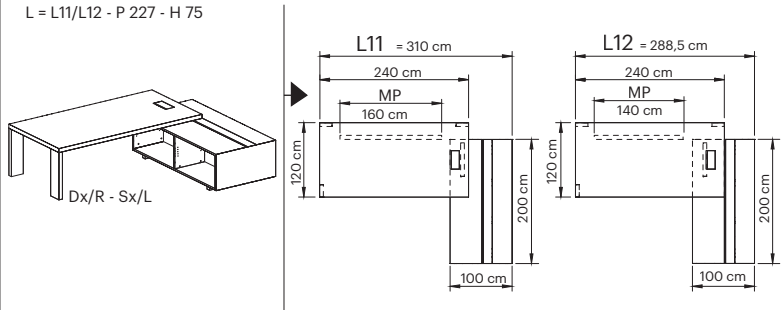

G3 Tavolo con gamba a "L" 80X70 / Desk with "L" shaped leg 80X70

G4 Tavolo con gamba a "L" 80X160 / Desk with "L" shaped leg 80X160

N.B.: i tavoli possono essere montati sui mobili di servizio (destri o sinistri) scegliendo tra 2 diverse posizioni. Per ogni soluzione compositiva è disponibile la dimensione del corrispondente modesty panel (vedi relativa quota indicata con MP) / Desks can be positioned on service units (right or left hand) in 2 different positions. Find the proper modesty panel to match the chosen composition (see sizes indicated with MP).

cassettiere su ruote / pedestals on castors

L 43,2 - P 56,5 - H 57,5

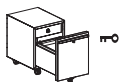

Cassettiera su ruote con un cassetto classificatore più cassetto interno / Pedestal on castors with one filing drawer and one internal drawer

tavoli caffè / coffee tables

L 60 - P 60 - H 40

L 120 - P 60 - H 40

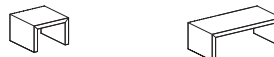

Con serratura / With lock

accessori / accessories

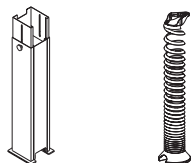

ø 6 / ø 8

L 36 - P 15,5 - H 8

L 38 - P 38 - H 8

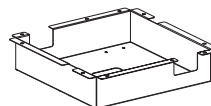
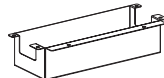

Per top access tavoli scrivania/tavoli riunione
Top access for desk and meeting tables

Per tavolo riunione quadrato L 140 o Ø 140
For square 140x140, and round Ø 140, meeting table

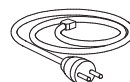
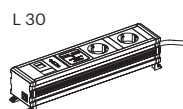
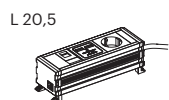

NOTA BENE - NOTES: Per la scelta dei contenitori e degli accessori vari, consultare il relativo listino o catalogo / To choose storage units and accessories, please check correspondent price list or catalogue

N.B.: LE DIMENSIONI SONO ESPRESSE IN CM - CONSULTARE IL LISTINO PREZZI PER LE CARATTERISTICHE TECNICHE, I CODICI DEGLI ARTICOLI E DELLE FINITURE.
N.B.: DIMENSIONS ARE STATED IN CM - FOR TECHNICAL CHARACTERISTICS, ARTICLE CODE NUMBERS AND FINISHING SEE PRICE LIST.

Elements

ante piene / wooden doors

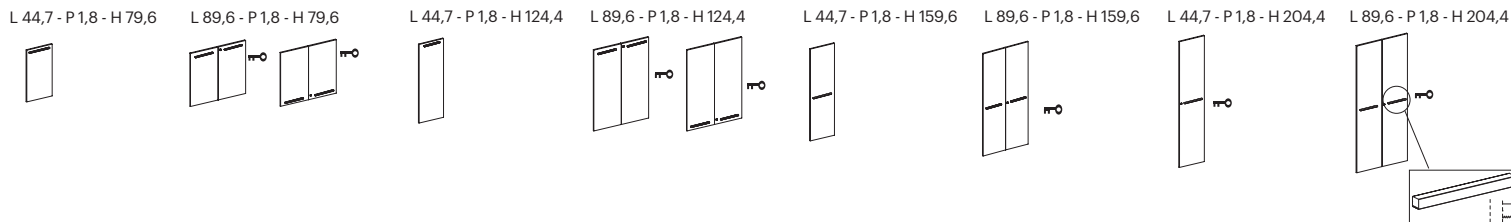

ante in vetro acidato con telaio in alluminio anodizzato / acetated glass doors with anodised aluminium frame

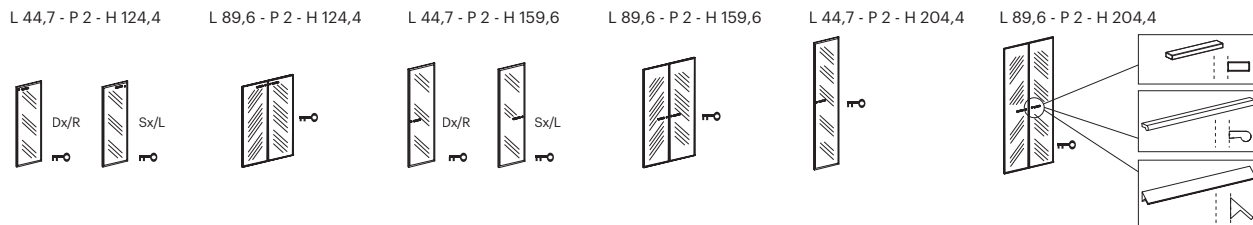

ante in vetro retrolaccato con telaio in alluminio anodizzato / rear-lacquered glass doors with anodised aluminium frame

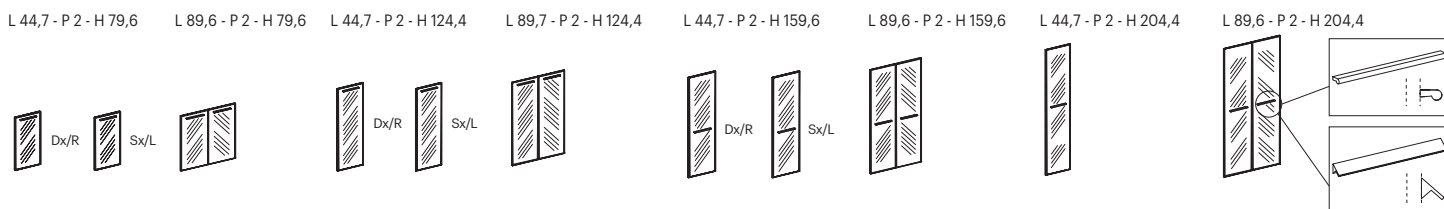

⇒ **Conserratura / With lock**

Per le eventuali composizioni con i contenitori di serie DV500. Archiviazione consultare il relativo listino e manuale tecnico / For compositions with DV500 standard storage units, please refer to correspondent price list and technical book

componenti per contenitori laccati / components for lacquered storage units

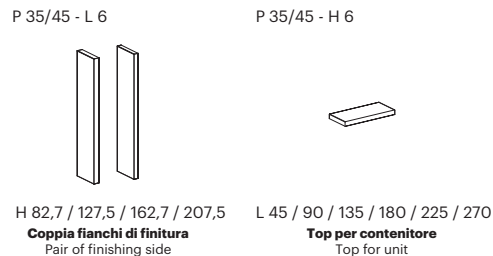

contenitore con classificatore complanare H. 75 / desk height filing drawer unit H.75

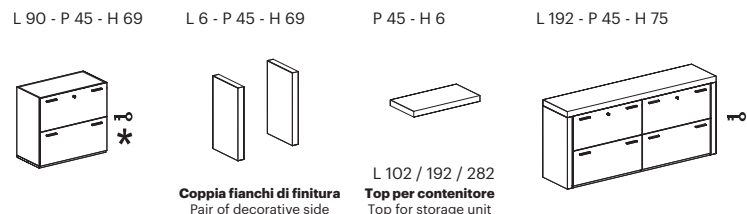

⇒ **Conserratura / With lock**

★ **N.B.: Scocca contenitore in melaminico / Note: Storage unit body in melamine**

boiserie

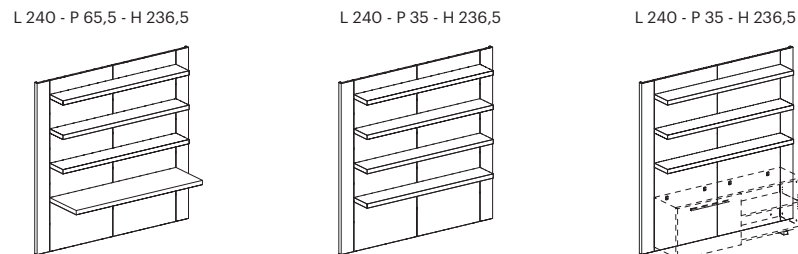

madia / credenza unit



Per abbinamento con la madia
For compositions with credenza unit