





KELLY

Small Sphere 40

FEATURES

- Frame:** Metal
- Diffuser:** Glass
- Dimmable:** Yes
- Dimmer:** Not Included
- Bulb:** Not Included

BULB

-  **E27 Classic A60** 3 x max 46W eco
- or _____
-  **E27 CFL [compact]** 3 x max 23W
- or _____
-  **E27 LED** 3 x max available

SPECIFICATION SHEET

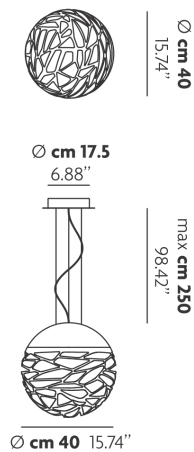





CERTIFICATION



PHOTOMETRIC CURVE

None

FRAME	DIFFUSER	LED COLOUR	CODE
 Matt White 9010	 Glossy Milk White	Optionally	141003
 Coppery Bronze	 Glossy Milk White	Optionally	141250





KELLY

Medium Sphere 50

FEATURES

- Frame:** Metal
- Diffuser:** Glass
- Dimmable:** Yes
- Dimmer:** Not Included
- Bulb:** Not Included

BULB

-  **E27 Classic A60** 3 x max 46W eco
- or _____
-  **E27 CFL [compact]** 3 x max 23W
- or _____
-  **E27 LED** 3 x max available

SPECIFICATION SHEET

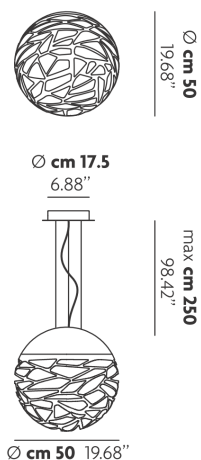

CERTIFICATION





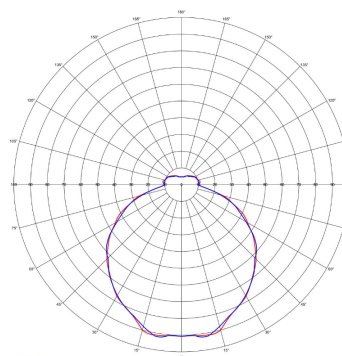

PHOTOMETRIC CURVE

DIAGRAMMA POLARE (cd/klm)



Codice CIE: 43 73 02 M 34
 Rendimento: LOR = 34.1, ULR = 84.3, ULCR = 15.7
 Apertura base: C0 = 180°, C1 = 118.5°, C2 = 71.5°
 Asimmetria: Max = 92.0 cd/klm, C = 30.0°, gamma = 8.0°
 Orientamento: C° = Indicazione, C' = Rilascio

FRAME	DIFFUSER	LED COLOUR	CODE
 Matt White 9010	 Glossy Milk White	Optionally	141004
 Coppery Bronze	 Glossy Milk White	Optionally	141269





KELLY

Large Sphere 80

FEATURES

- Frame:** Metal
- Diffuser:** Glass
- Dimmable:** Yes
- Dimmer:** Not Included
- Bulb:** Not Included

BULB

-  **E27 Classic A60** 4 x max 46W eco
- or _____
-  **E27 CFL [compact]** 4 x max 23W
- or _____
-  **E27 LED** 4 x max available

CERTIFICATION



PHOTOMETRIC CURVE

None

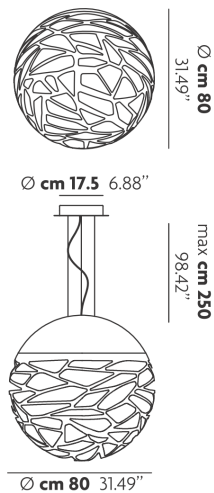

SPECIFICATION SHEET



FRAME

-  Matt White 9010
-  Coppery Bronze

DIFFUSER

-  Glossy Milk White
-  Glossy Milk White

LED COLOUR

- Optionally
- Optionally

CODE

- 141005
- 141270

KELLY SO2_SO3

Suspension | Small_Medium Sphere

220-240V

 3x max 46W eco Classic A60 (E27)

 3x max 23W CFL compact (E27)

 3x max Classic A60 LED (E27)
L max cm 12

Ita-Eng

2016.07.12



ASSEMBLAGGIO SFERA

- 1) Aprire entrambi gli imballi ma non estrarne il contenuto.
- 2) Prendere il vetro circolare [D] dalla scatola più piccola ed appoggiarlo nell'apposita sede [S] sul diffusore traforato [M] che è all'interno della scatola più grande. (Fig.1)
- 3) Togliere la montatura dalla scatola più piccola.
- 4) Svitare la vite [Y] dalla cupola piena [Q] per liberare la montatura interna [T]
- 5) Allontanare la cupola [Q] facendola scorrere lungo i cavi preinstallati.
- 6) Inserire le lampadine nei portalampade.
- 7) Svitare i tre finalini [R] dal diffusore traforato [M]
- 8) Infilare l'anello [H] tra la montatura interna [D] e la cupola piena [F]
- 9) Posizionare ora le tre braccia della struttura interna [T] sui perni sul diffusore traforato [M] e bloccarla avvitando i finalini [R]
- 10) Avvitare i grani filettati [P] sulle braccia per bloccare il vetro [D](Fig.2)
- 11) Riposizionare la cupola piena [Q] sulla montatura [M]
- 12) Bloccare infine la cupola avvitando la vite [Y]

Nota: Per sostituire le lampadine svitare la vite [Y] (Fig.1) per alzare la cupola [Q] ed accedere ai portalampadine.

ASSEMBLY SPHERE

- 1) Open both boxes without removing the contents.
- 2) Take the glass diffuser [D] from the smaller box and place it on top of the perforated shade [M] inside the larger box (Fig.1)
- 3) Remove the fixture from the smaller box.
- 4) Undo the screw [Y] using the tool provided.
- 5) Slide up the dome [Q].
- 6) Install the light bulbs into the lamp holders.
- 7) Remove the three nuts [R] from the perforated shade [M]
- 8) Place the plastic ring [H] on top of the perforated shade.
- 9) Place the lamp holders frame [T] and secure it in position with the nuts [R]
- 10) Tighten the grub screws [P] to secure the glass diffuser [D](Fig.2)
- 11) Slide the dome [Q] down
- 12) Secure the dome with the screw [Y]

Note: To replace a burnt out light bulb, undo the screw [Y] (Fig.1) and slide up the dome [Q] to access the lamp holders.

Fig.1

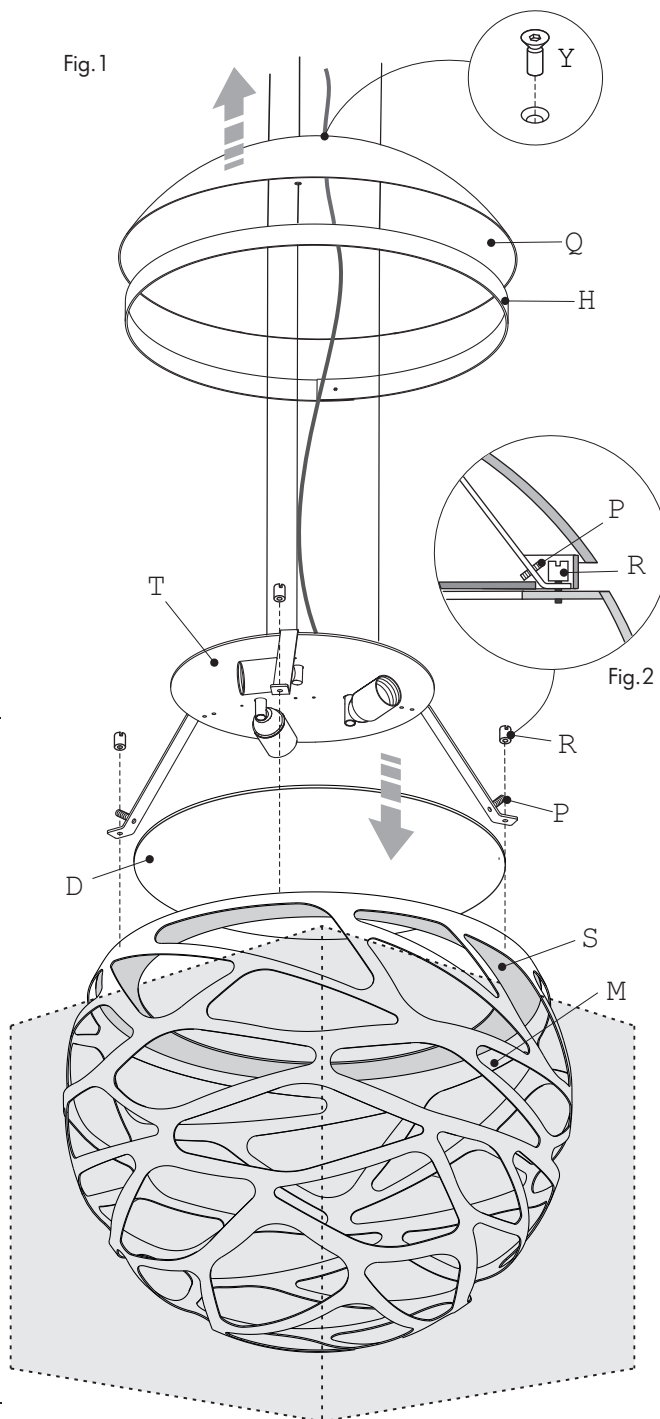

Fig.2

Studio Italia Design garantisce i suoi prodotti essere privi da difetti di materiale e di lavorazione per la durata di un anno dalla consegna. Durante tale periodo Studio Italia Design riparerà o sostituirà, a sua discrezione, i prodotti che hanno dato prova di difetto. Questa garanzia non è applicata a danni risultanti dall'incidente, alterazione, manomissione, abuso o negligenza. Ogni modifica può compromettere la sicurezza rendendo l'apparecchio pericoloso. Studio Italia Design declina ogni responsabilità per i prodotti modificati. L'apparecchio non deve essere installato in posizioni o in applicazioni diverse da quelle indicate nelle istruzioni di montaggio.

Studio Italia Design warrants its to be free from defects in materials and workmanship for a period of one year date of delivery. During this warranty period Studio Italia Design will repair or replace, at its option, product that are proven to be defective. This warranty does not apply to damages resulting from accidental, alteration, tampering, misuse, negligence or abuse. Any modification may compromise safety causing the product to become dangerous. Studio Italia Design declines all responsibility for products that are modified. Fixture must not be installed in any position or used in a different way than shown in his instructions.

Conservare le istruzioni per una manutenzione futura. L'apparecchio deve essere installato da personale qualificato
Keep these instructions for future reference. To be installed by a qualified licensed electrician only



STUDIO ITALIA DESIGN | Via Pialoi, 32, 30020, Marcon, Venezia, ITALY | www.studioitaliadesign.com | info@studioitaliadesign.com

STUDIO
ITALIA DESIGN

KELLY SO2_SO3

Suspension | Small_Medium Sphere

Ita-Eng

2016.07.12



Disinserire la tensione prima di operare sull'apparecchio

ISTRUZIONI DI MONTAGGIO

- 1) Svitare il grano [E] e rimuovere il coperchio [C] dalla scatola a soffitto [A] (vedi Fig.3 e Fig.7)
- 2) Fissare al soffitto la scatola [A] attraverso i fori asolati [G]
- 3) Regolare l'altezza della lampada agendo sulle tre funi d'acciaio [L] regolando i registri [F] (vedi Fig.4 per l'uso dei registri).
- 4) Regolare la lunghezza del cavo elettrico attraverso il bloccacavo a ponte [P] all'interno della scatola a soffitto [A] (vedi particolare Fig.5)
- 5) Eseguire il collegamento elettrico ai morsetti [B](Fig.6)
- 6) Riposizionare il coperchio [C] sulla scatola a soffitto [A] bloccandolo con il grano [E]

Before installing turn off the power to the electrical box

MOUNTING INSTRUCTIONS

- 1) Undo the grub screw [E] and slide down the ceiling rose cap [C] (see Fig.3 and Fig.7)
- 2) Fix the ceiling plate [A] to the ceiling using appropriate fixings [G]
- 3) Adjust the length of the suspension wires [L] using the wire grips [F] (see Fig.4 for further instructions).
- 4) Adjust the length of the power cable using the cable grip [P] inside the ceiling plate (see detail on Fig.5)
- 5) Make the connection of the power supply to the terminal blocks [B] (Fig.6)
- 6) Slide the cap [C] over the ceiling plate and block it screwing the grub screw [E]

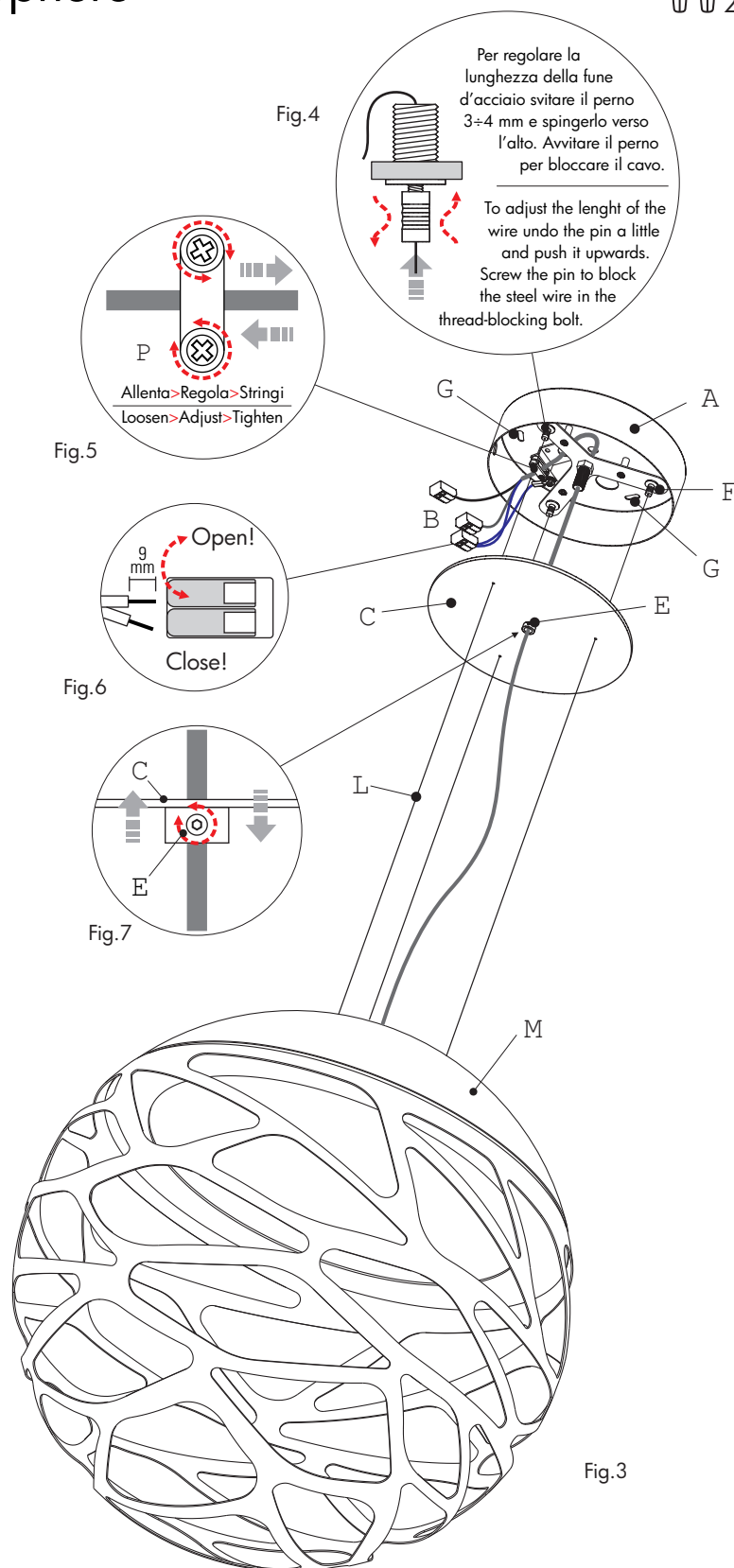

Studio Italia Design garantisce i suoi prodotti essere privi da difetti di materiale e di lavorazione per la durata di un anno dalla consegna. Durante tale periodo Studio Italia Design riparerà o sostituirà, a sua discrezione, i prodotti che hanno dato prova di difetto. Questa garanzia non è applicata a danni risultanti dall'incidente, alterazione, manomissione, abuso o negligenza. Ogni modifica può compromettere la sicurezza rendendo l'apparecchio pericoloso. Studio Italia Design declina ogni responsabilità per i prodotti modificati. L'apparecchio non deve essere installato in posizioni o in applicazioni diverse da quelle indicate nelle istruzioni di montaggio.

Studio Italia Design warrants its to be free from defects in materials and workmanship for a period of one year date of delivery. During this warranty period Studio Italia Design will repair or replace, at its option, product that are proven to be defective. This warranty does not apply to damages resulting from accidental, alteration, tampering, misuse, negligence or abuse. Any modification may compromise safety causing the product to become dangerous. Studio Italia Design declines all responsibility for products that are modified. Fixture must not be installed in any position or used in a different way than shown in his instructions.

Conservare le istruzioni per una manutenzione futura. L'apparecchio deve essere installato da personale qualificato
Keep these instructions for future reference. To be installed by a qualified licensed electrician only



STUDIO ITALIA DESIGN | Via Pialoi, 32, 30020, Marcon, Venezia, ITALY | www.studioitaliadesign.com | info@studioitaliadesign.com

STUDIO
ITALIA DESIGN