



QUINTESSENZA CERAMICHE S.r.l. www.quintessenzaceramiche.it - info@quintessenzaceramiche.it

ORIGAMI

Rivestimento in pasta bianca
White body wall tiles

26,6X23CM
10,5"X9"
9/17MM

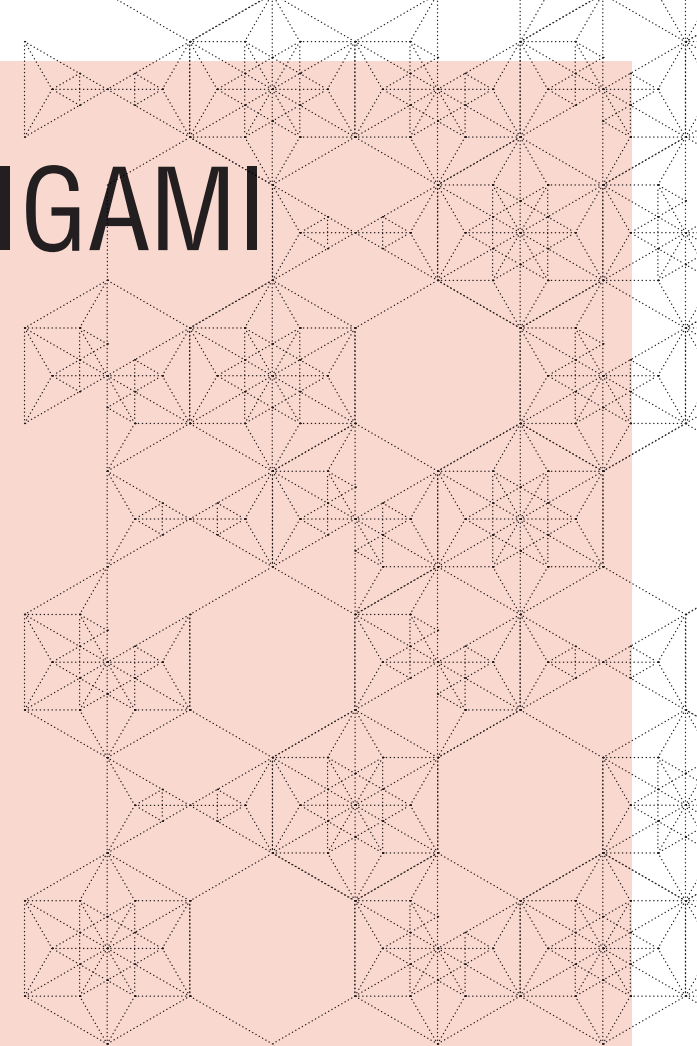

QUINTESSENZA

— CERAMICHE —

ORIGAMI

Rivestimento in pasta bianca
White body wall tiles

26,6X23CM
10.5"X9"

9/17MM

base bianco ORI101M ■07

matt

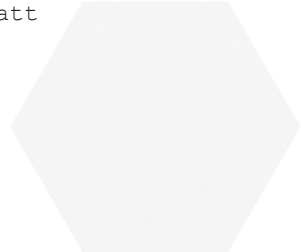

26,6x23

origami1 bianco ORI104M ■19

matt



26,6x23

origami3 bianco ORI108M ■19

matt

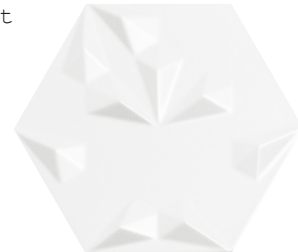

thick.15mm max

26,6x23

origami2 bianco ORI107M ■19

matt

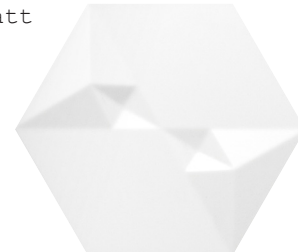

thick.15mm max

26,6x23

base nero ORI102M ■07

matt

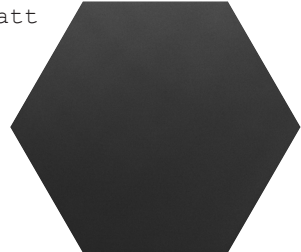

thick.9mm max

26,6x23

origami1 nero ORI105M ■19

matt

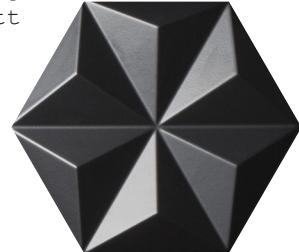

thick.17mm max

26,6x23

dimensioni
sizes

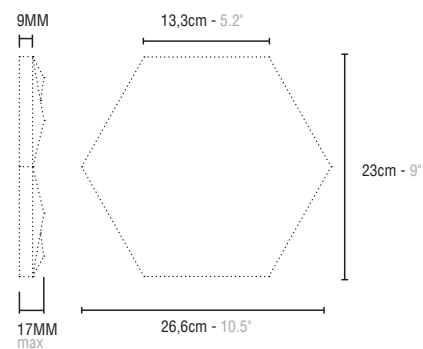

imballi
packaging

formato (cm) size (cm)	Pz	Mq	Kg
origami base 26,6x23	19	0,87	14,05
origami 1 26,6x23	14	0,64	11,65
origami 2 26,6x23	13	0,6	10,30
origami 3 26,6x23	13	0,6	10,30

scatola
box



formato (cm) size (cm)	Box	Mq	Kg
origami base 26,6x23	48	41,76	694,4
origami 1 26,6x23	48	30,72	579,2
origami 2 26,6x23	48	28,8	514,4
origami 3 26,6x23	48	28,8	514,4

paletta
pallet

