

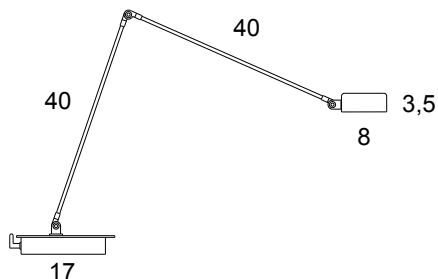



Cloe

Tommaso Cimini, 1979

Table standing lamp of metal with an articulated arm, adjustable in all positions and equipped with a handy "jack" connection: flat base in metal with electronic transformer. 360° rotating head.



TECHNICAL DATAS	Product Name (code)	Cloe (07)
	Certificates	CE
	Norms	EN 60-598-1 (CEI 34-21)
	Light sources	MAX 50W 12V - GY6.35 (35W energy saver included)
	Available	230V (Europe) - 120V (USA - Japan) - 240V (UK) <i>(fittings come with appropriate transformer and plug)</i>
	Insulation Class	II
	Protection Class	IP20
	Packaging	0,013m³ - 3,1Kg

COLOURS			
	Black	White	Brushed Nickel

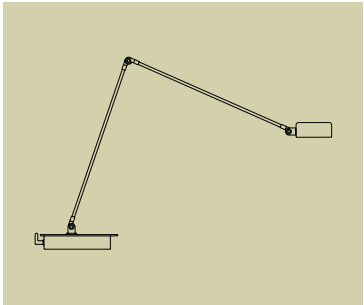
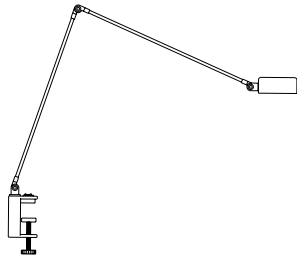
FAMILY		
	Cloe	Cloe Morsetto



Cloe Morsetto

Tommaso Cimini, 1980

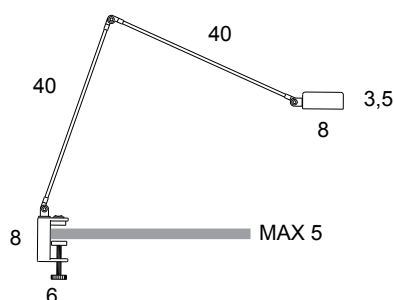
Clamp lamp for fixing to desk and to wall, with an adjustable and articulated arm, 360° rotating head. Clamp-base in die-cast aluminium, wall attachment in plastics. Electronic transformer mounted on cable.



TECHNICAL DATAS	Product Name (code)	Cloe Morsetto (08)
	Certificates	CE
	Norms	EN 60-598-1 (CEI 34-21)
	Light sources	MAX 50W 12V - GY6.35 (35W energy saver included)
	Available	230V (Europe) - 120V (USA - Japan) - 240V (UK) <i>(fittings come with appropriate transformer and plug)</i>
	Insulation Class	III
	Protection Class	IP20
	Packaging	0,013m³ - 2,64Kg

COLOURS			
	Black	White	Brushed Nickel

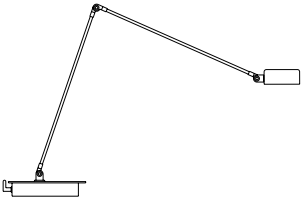
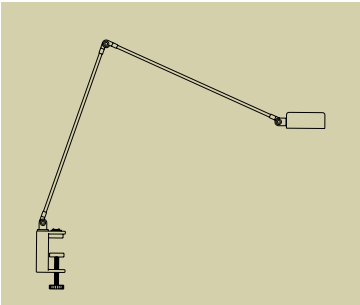
FAMILY		
	Cloe	Cloe Morsetto