

Multi X Light

Yaacov Kaufman, 2004

Table lamp made of metal: the upper body itself, composed by a stainless steel structure, is totally adjustable. The switch is on the body.

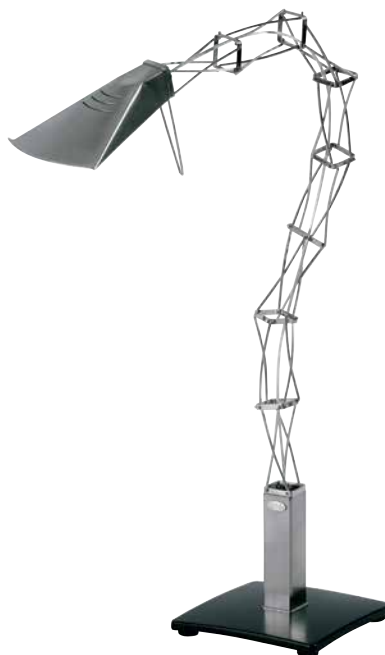
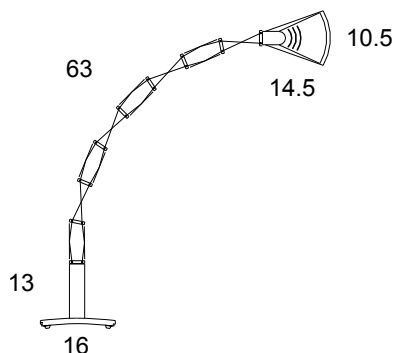

TECHNICAL DATAS	Product Name (code)	Multi X Light (25)
	Certificates	CE
	Norms	EN 60-598-1 (CEI 34-21)
	Light sources	MAX 60W HAL - G9 (48W energy saver included - only for 230V)
	Available	230V (Europe) - 120V (USA - Japan) - 240V (UK) <i>(fittings come with appropriate plug)</i>
	Insulation Class	II
	Protection Class	IP20
Packaging	0,026m³ - 2,7Kg	

COLOURS		
	Black Soft-touch	Brushed Nickel

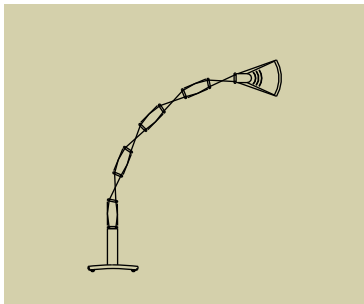
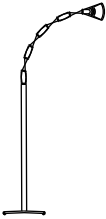
FAMILY		
	Multi X	Multi X Terra

Multi X Terra Light

Yaacov Kaufman, 2004

Floor lamp made of metal: the upper body itself, composed by a stainless steel structure, is totally adjustable. The switch is on the body.

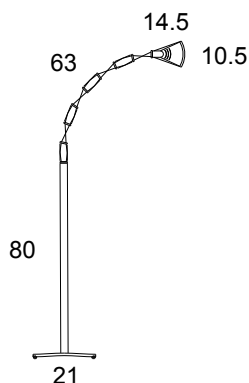

TECHNICAL DATAS	Product Name (code)	Multi X Terra Light (27)
	Certificates	CE
	Norms	EN 60-598-1 (CEI 34-21)
	Light sources	MAX 60W HAL - G9 (48W energy saver included - only for 230V)
	Available	230V (Europe) - 120V (USA - Japan) - 240V (UK) <i>(fittings come with appropriate plug)</i>
	Insulation Class	II
	Protection Class	IP20
Packaging	0,081m³ - 4,3Kg	

COLOURS		
	Black Soft-touch	Brushed Nickel

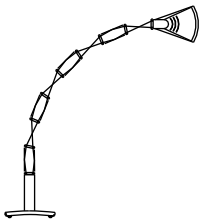
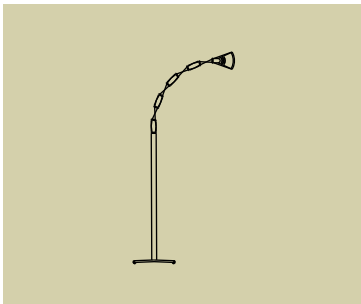
FAMILY		
	Multi X	Multi X Terra