

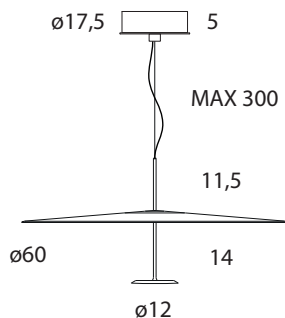





DOT 600

Foster+Partners , 2015

Suspended lamp for indirect lighting with integrated LED source and diffused light optic system.
Aluminium structure with steel matt-painted reflector.
1-10V dimming or DALI dimming available.



TECHNICAL DATAS	Product Name (code)	DOT 600 (cod.130)
	Certificates	
	Norms	EN 60598-1 / EN55015 / UL 2108:2015 / CSA C22.2#9.0:1996
	Light sources	23W LED [3000K • 2350 lm]
	Available	230V (Europe) - 120V (USA - Japan) - 240V (UK)
	Insulation Class	I
	Protection Class	IP20
Packaging	0,170 m³ - 10 Kg	

COLOURS				
	Col. 01XO Anodised black	Col. 03XO Anodised red	Col. 50XO Anodised brass	Col. 51XO Anodised blue

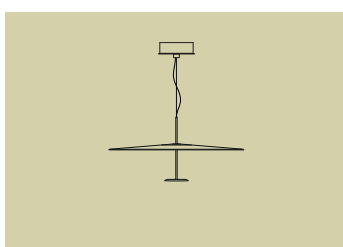
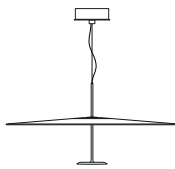
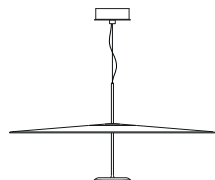
FAMILY			
	DOT 600	DOT 800	DOT 1100



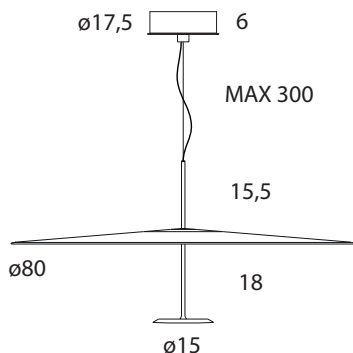

DOT 800

Foster+Partners , 2015

Suspended lamp for indirect lighting with integrated LED source and diffused light optic system.
Aluminium structure with steel matt-painted reflector.
1-10V dimming or DALI dimming available.



TECHNICAL DATAS	Product Name (code)	DOT 800 (cod. 131)
	Certificates	
	Norms	EN 60598-1 / EN55015 / UL 2108:2015 / CSA C22.2#9.0:1996
	Light sources	41W LED [3000K • 3250 lm]
	Available	230V (Europe) - 120V (USA - Japan) - 240V (UK)
	Insulation Class	I
	Protection Class	IP20
	Packaging	0,298 m³ - 18 Kg

COLOURS				
	Col. 01XO	Col. 03XO	Col. 50XO	Col. 51XO
	Anodised black	Anodised red	Anodised brass	Anodised blue

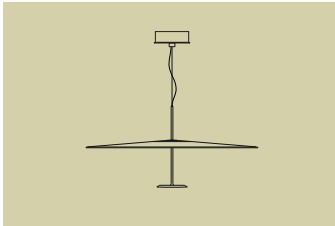
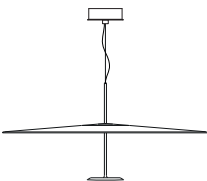
FAMILY			
	DOT 600	DOT 800	DOT 1100



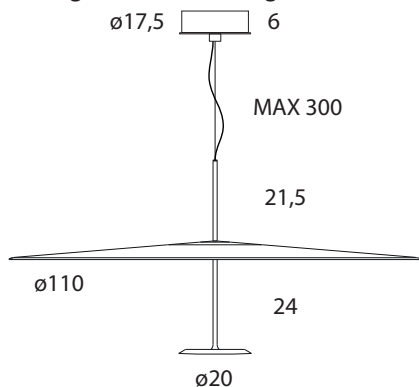

DOT 1100

Foster+Partners , 2015

Suspended lamp for indirect lighting with integrated LED source and diffused light optic system. Aluminium structure with steel matt-painted reflector. 1-10V dimming or DALI dimming available.



TECHNICAL DATAS	Product Name (code)	DOT 1100 (cod. 132)
	Certificates	
	Norms	EN 60598-1 / EN55015 / UL 2108:2015 / CSA C22.2#9.0:1996
	Light sources	55W LED [3000K • 4750 lm]
	Available	230V (Europe) - 120V (USA - Japan) - 240V (UK)
	Insulation Class	I
	Protection Class	IP20
	Packaging	0,560 m³ - 25 Kg

COLOURS				
	Col. 01XO	Col. 03XO	Col. 50XO	Col. 51XO
	Anodised black	Anodised red	Anodised brass	Anodised blue

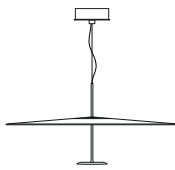
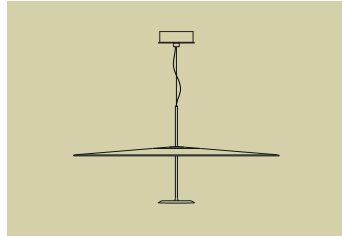
FAMILY			
	DOT 600	DOT 800	DOT 1100