

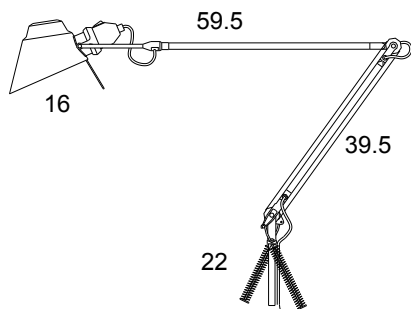



Tangram

Walter Monici, 1992

Multi directional two arms table lamp: 360° rotating head. It can be used with different supports. Structure in aluminium and steel.



TECHNICAL DATAS	Product Name (code)	Tangram (101)
	Certificates	CE
	Norms	EN 60-598-1 (CEI 34-21)
	Light sources	MAX 100W I/HAL- E27/E26 (not included)
	Available	230V (Europe) - 120V (USA - Japan) - 240V (UK) <i>(fittings come with appropriate plug)</i>
	Insulation Class	II
	Protection Class	IP20
	Packaging	0,042m³ - 1,94Kg

COLOURS			
	Black Soft-touch	Anodised Aluminium	Brushed Nickel

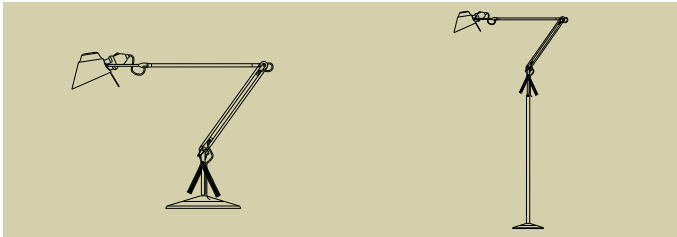
FAMILY		
	Tangram	Tangram Terra





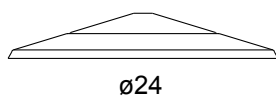

Tangram Table Base

Walter Monici - 1992

Base, dedicated to Tangram, made of aluminium and steel.



TECHNICAL DATAS	Product Name (code)	Tangram Table Base (114)
	Certificates	CE
	Norms	
	Light sources	
	Available	
	Insulation Class	
	Protection Class	
	Packaging	0,005m³ - 3,13Kg

COLOURS			
	Black Soft-touch	Crackled Grey	Brushed Nickel
	For body finish:		
			
	Black Soft-touch	Anodised Aluminium	Brushed Nickel

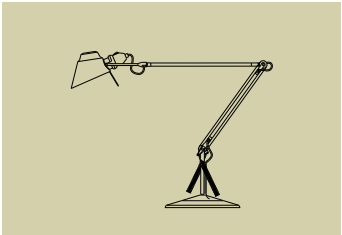
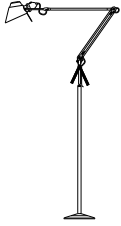
FAMILY		
	Tangram	Tangram Terra





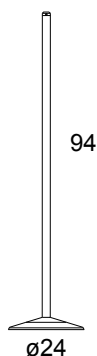

Tangram Floor Base



Walter Monici, 1992

Floor base, dedicated to Tangram, made of aluminium and steel.

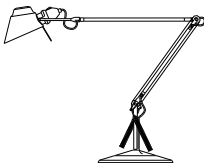

TECHNICAL DATAS	Product Name (code)	Tangram floor base (cod. 125)
	Certificates	CE
	Norms	
	Light sources	
	Available	
	Insulation Class	
	Protection Class	
	Packaging	0,014m³ - 5,0Kg

COLOURS			
	Black Soft-touch	Crackled Grey	Brushed Nickel
	For body finish:		
			
	Black Soft-touch	Anodised Aluminium	Brushed Nickel

FAMILY		
	Tangram	Tangram Terra

Clamp-on

Tangram/Naomi

Clamp on, dedicated to Tangram and Naomi, made out of die-cast aluminium and steel.

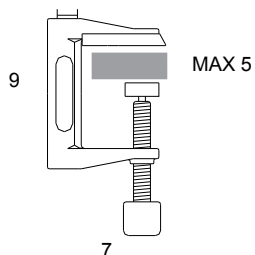

Product Name (code) **Clamp-on (112)**
Packaging **0,005m³ - 0,28Kg**

Polished Aluminium

Wall Attachment

Tangram/Naomi

Wall attachment, dedicated to Tangram and Naomi, made out of die-cast aluminium.

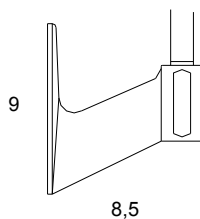

Product Name (code) **Wall Attachment (113)**
Packaging **0,005m³ - 0,22Kg**

Polished Aluminium

Table Mount

Tangram/Naomi

Table mount, dedicated to Tangram and Naomi, made out of aluminium.

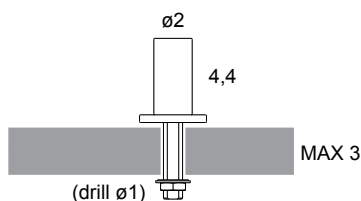

Product Name (code) **Table Mount (332)**
Packaging **0,002m³ - 0,16Kg**

Polished Aluminium