

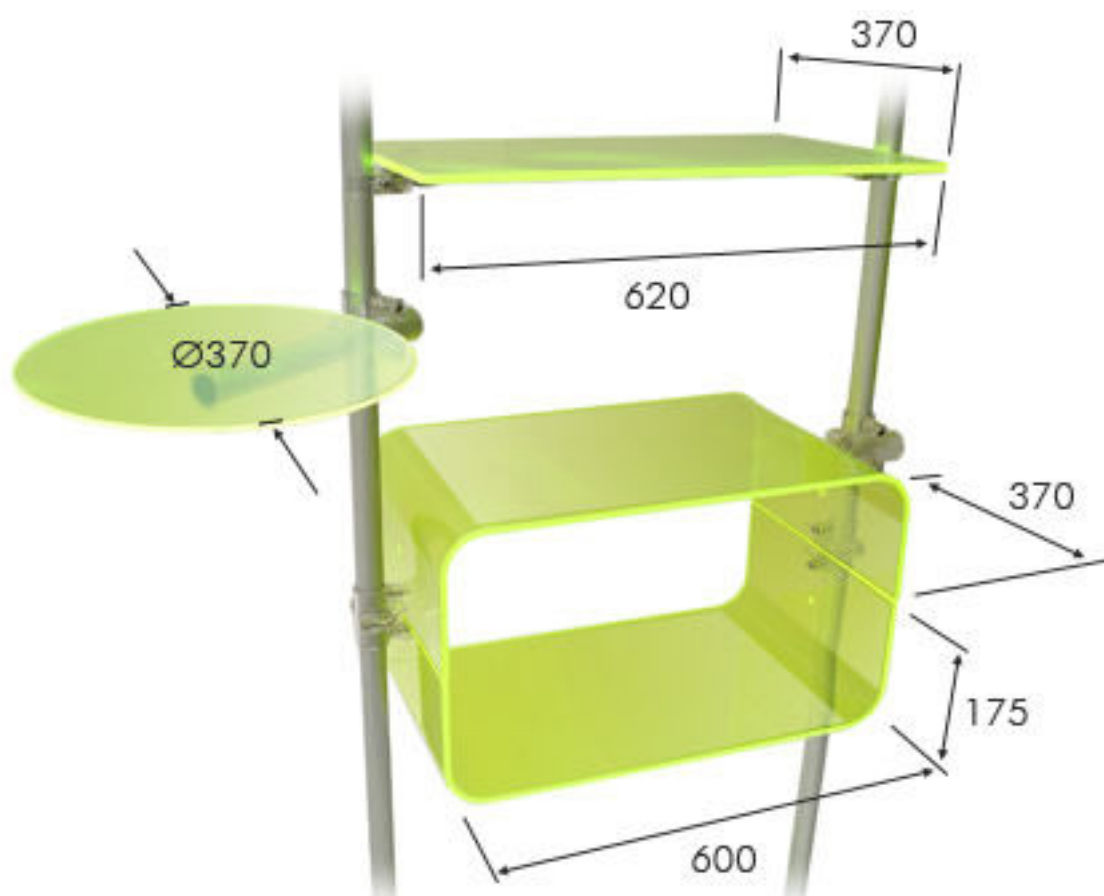

## Dimensioni/Dimensions

---



# Il sistema/The system

## MONTANTI VERTICALI / VERTICAL POLES

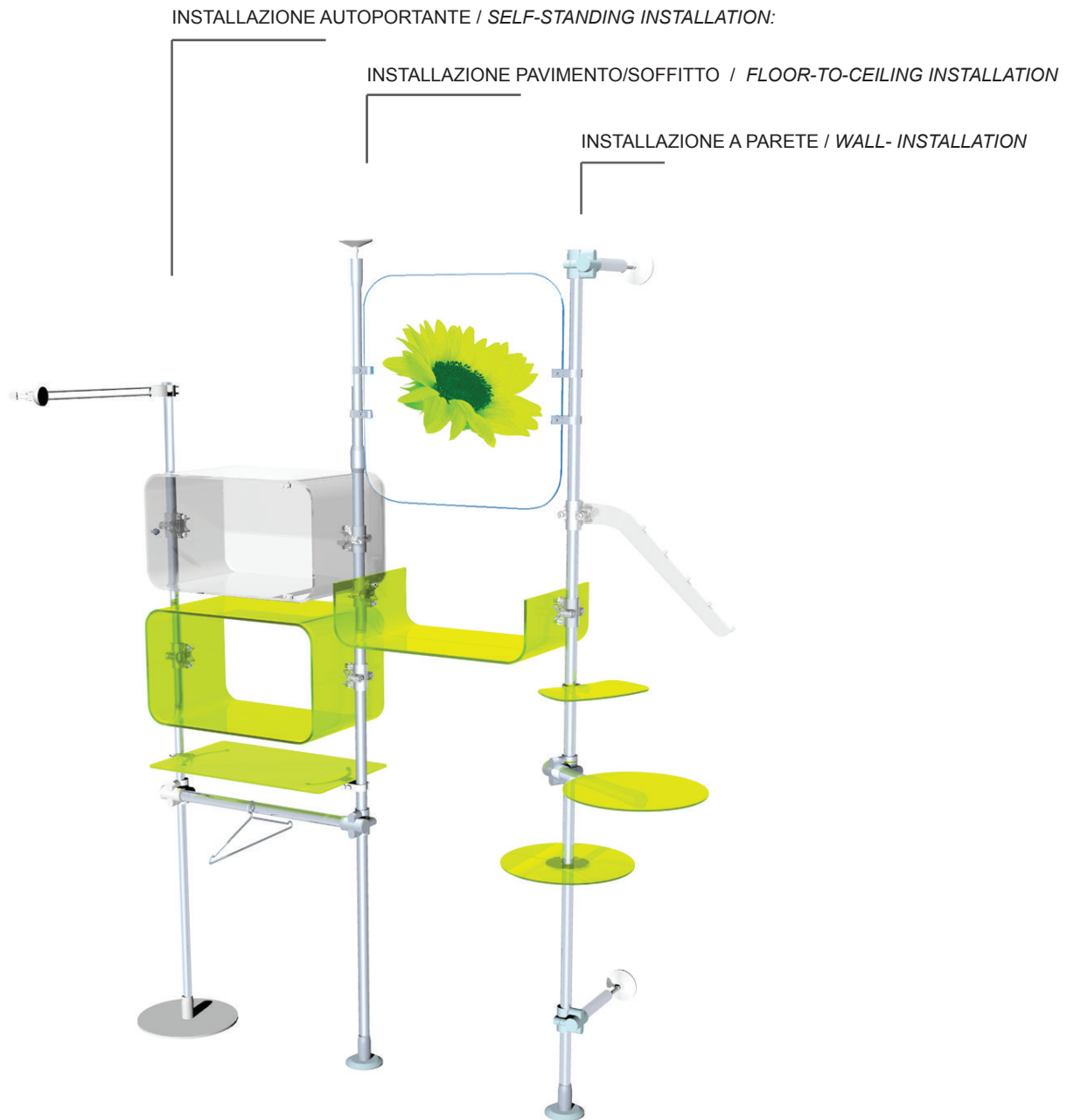

FLUOSHOP is a product by:  
Paxton Srl, Via delle Industrie, 2 - 26862 Guardamiglio (LO) - Italy  
Tel +39 0377 51209 Fax +39 0377 451114  
[www.paxton.it](http://www.paxton.it) - [info@paxton.it](mailto:info@paxton.it)  
FLUOSHOP is covered by international patents



**fluoshop<sup>®</sup>**

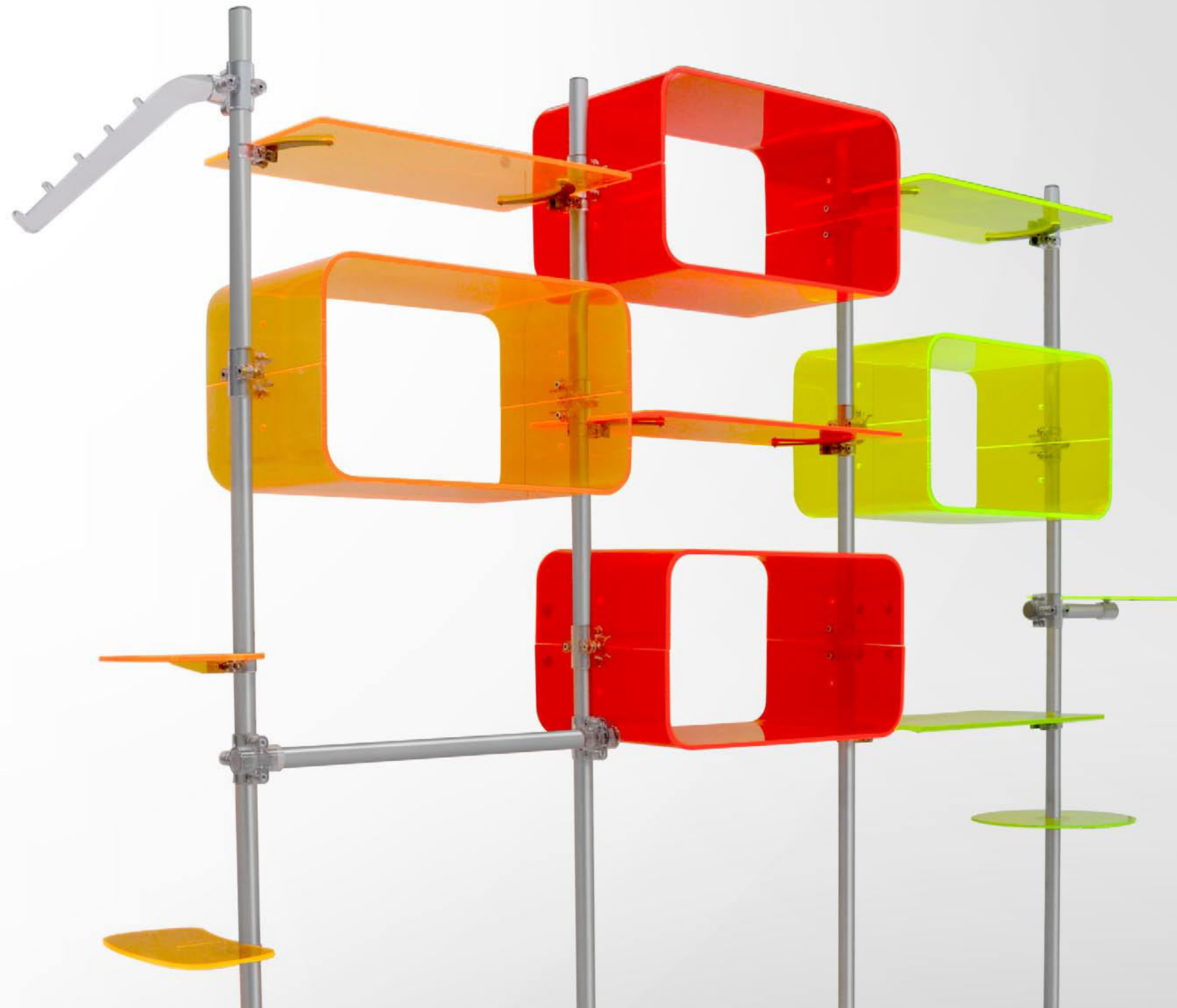

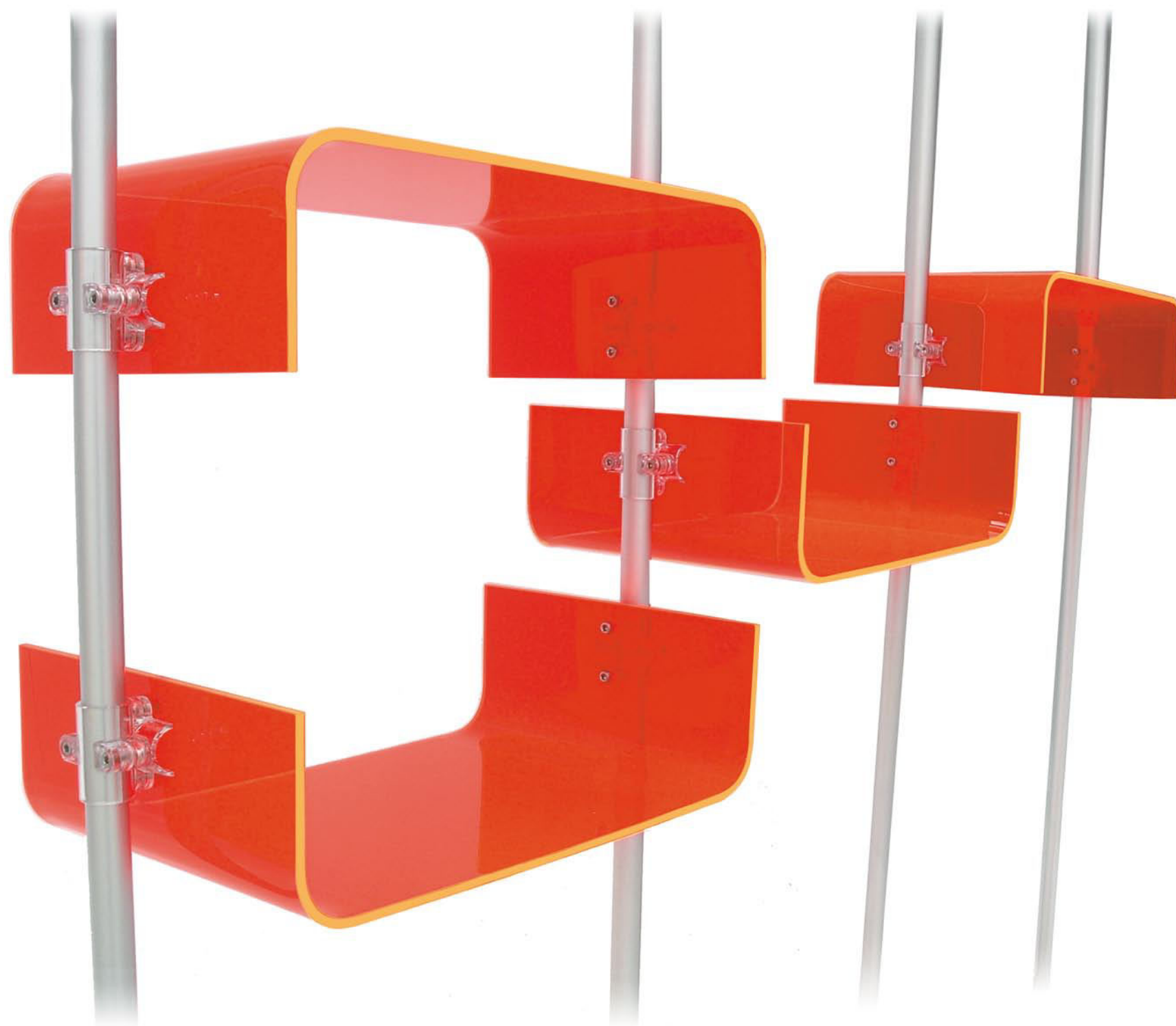

FluoShop è un sistema espositivo completo per l'allestimento di vetrine, negozi e showroom. Innovativo nei materiali e nel design, FluoShop è in grado di valorizzare anche gli spazi più semplici e anonimi, trasformandoli in ambienti dotati di carattere e originalità.

FluoShop is a complete display system for fitting out windows, stores and showrooms. Innovative as regards both materials and design, it allows to create configurations which are full of personality and originality, capable of taking advantage of the simplest and most anonymous spaces in an instant.

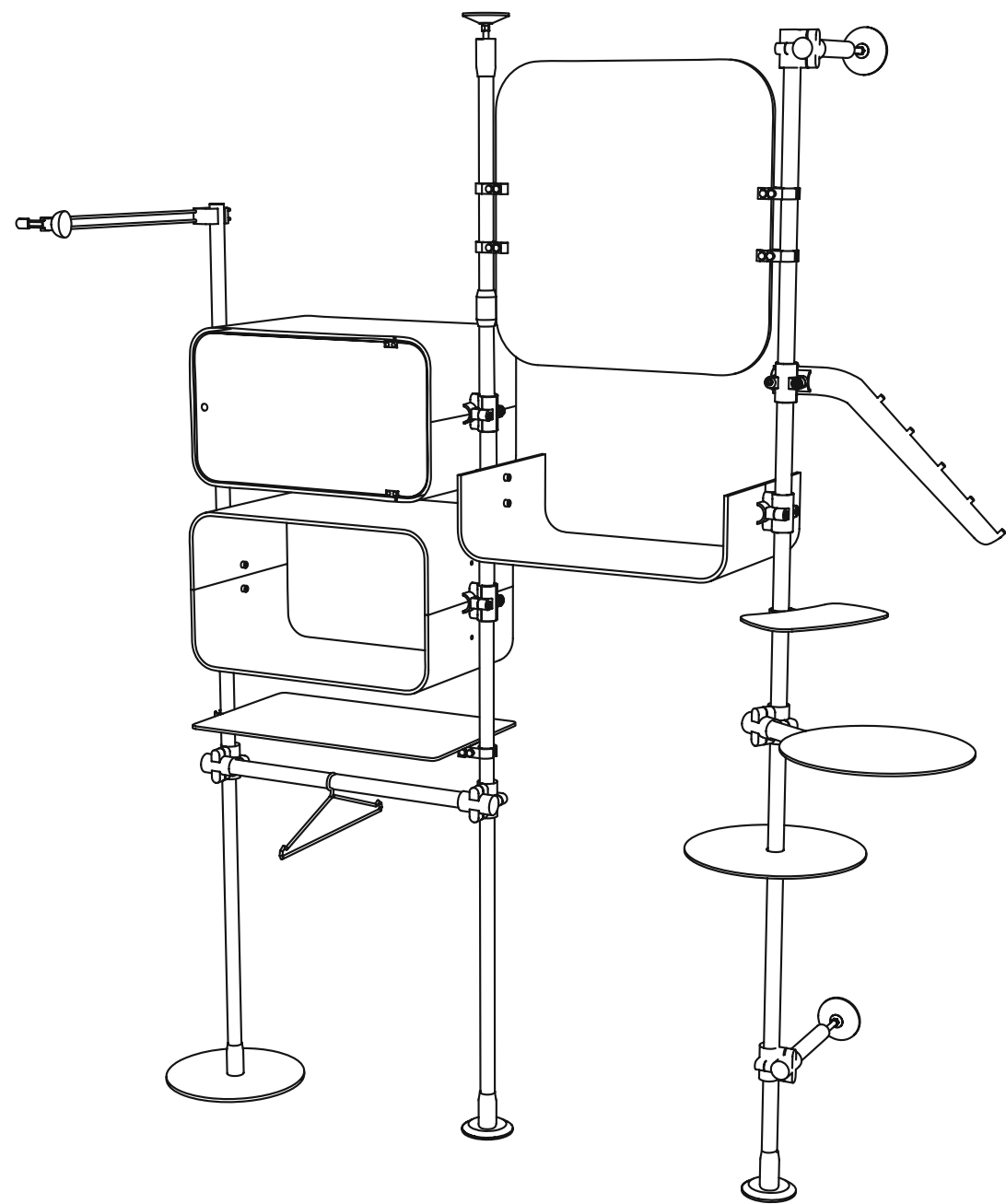

Il sistema Fluoshop include innumerevoli accessori, che lo rendono estremamente versatile e adatto ad esporre, con la massima originalità e con il massimo risalto, qualsiasi tipo di prodotto.

I ripiani sono realizzati in un innovativo materiale acrilico che si "illumina" quando è attraversato dalla luce. Grazie a questa caratteristica, i ripiani appaiono luminescenti lungo i bordi, pur in assenza di una fonte di illuminazione diretta. I montanti verticali di sostegno sono invece realizzati in alluminio anodizzato.

FluoShop is extremely versatile and suitable for displaying any type of product with the highest levels of originality and in the most prominent way possible.

The FluoShop range shelves are made with an innovative acrylic material which "lights up" when light passes through it. Thanks to this feature, the shelves appear luminescent along the edges, even when there is no direct light source. The vertical support poles, on the other hand, are made of aluminium.





Tutte le componenti del sistema FluoShop sono di facilissima installazione. La velocità di configurazione e la semplicità di montaggio rendono FluoShop il sistema ideale per un punto vendita in continua trasformazione. In pochi attimi, ciascuna composizione può essere completamente modificata e spostata all'interno del negozio. FluoShop è adatto alla realizzazione di display, comer, vetrine e arredamenti completi.

All the components of the FluoShop system are extremely easy to install. The speed of configuration and ease of assembly make FluoShop the ideal system for a continually changing point of sale. In just a few moments. Each configuration can be changed completely and moved within the store. FluoShop is suitable for creating displays, stores within stores, window displays and complete furnishing.



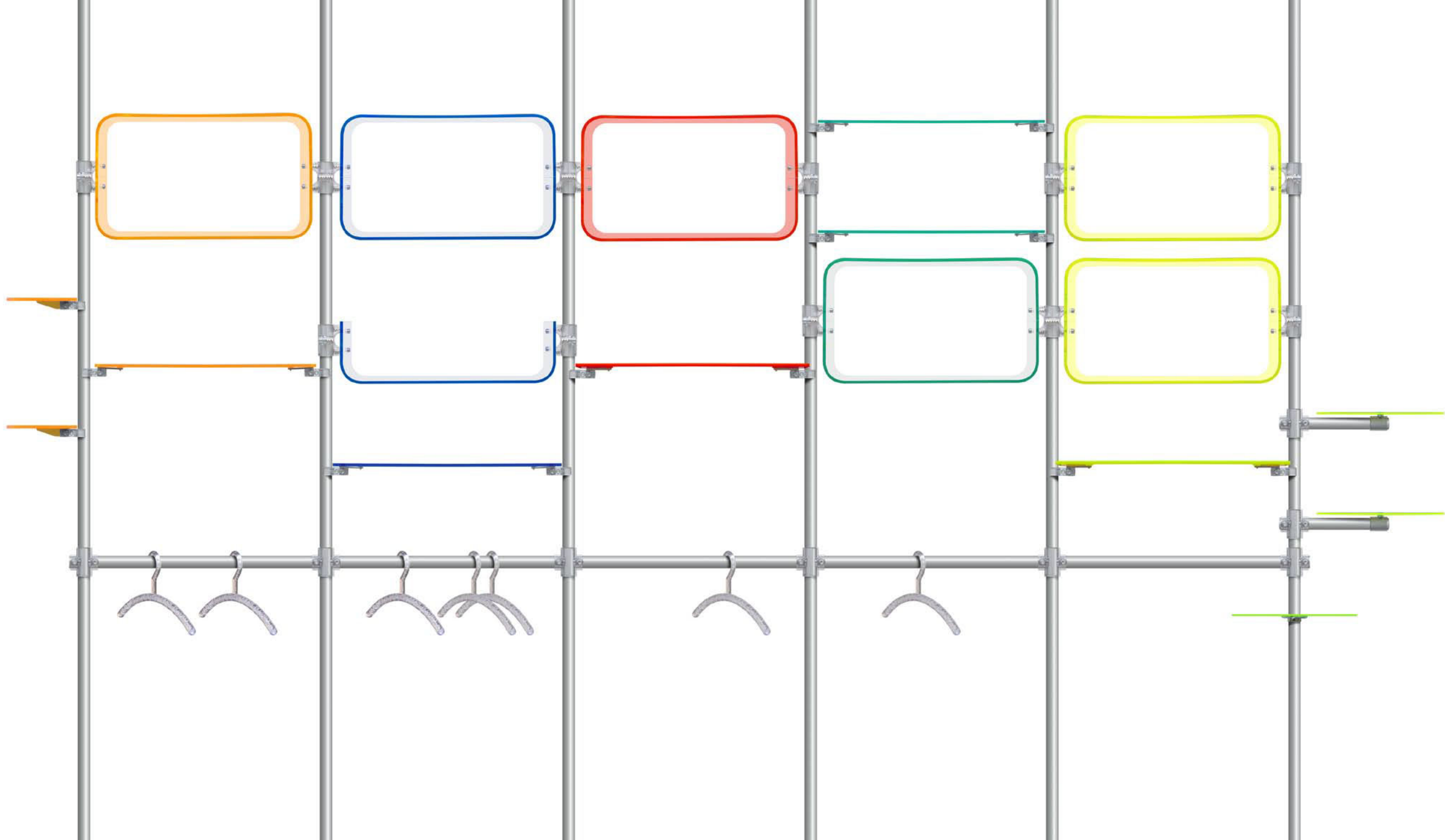







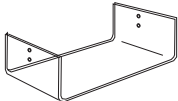

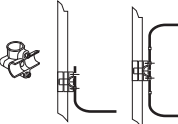
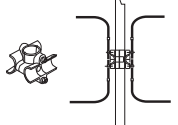
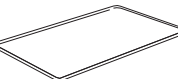
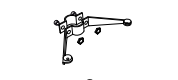

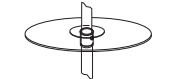
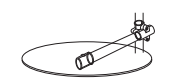

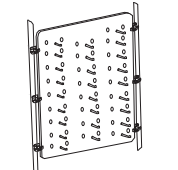



**paxton**

PAXTON SRL VIA DELLE INDUSTRIE, 2 - 26862 GUARDAM IGLIO (LO) ITALY TEL: +39 0377-51209  
FAX: +39 0377-451114 WEB: WWW.PAXTON.IT WWW.FLUOSYSTEM.COM

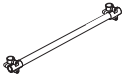
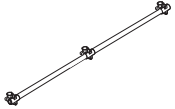
Codice/Code		Descrizione/Description	Dim lxxh mm	Materiale/Material	Colore/Colour
CRPM60TR		Mensola curvata a forma di "U"/ U-shaped curved shelf	600 x 370 x 175	PMMA	Trasparente/Transparent
CRPM60AZ					Blu/Blue
CRPM60GV					Giallo fluo/Fluo yellow
CRPM60RD					Rosso fluo/Fluo red
CRPM60BI					Bianco/White
CRPM60WF					Satinato/Frosted
FLBX60TR		Cabinet con serratura Lockable cabinet	600 x 370 x 350	PMMA	Tutto Trasparente/ All transparent
2PABP101		Giunto "piatto" singolo per cod. CRPM60/FLBX60 / "Plane" Single clamp for codes CRPM60/FLBX60	76 x 76 x 58	Policarbonato/ Polycarbonate	Trasparente/Transparent
CCABP101		Giunto "piatto" doppio per cod. CRPM60/FLBX60 / "Plane" Double clamp for codes CRPM60/FLBX60	76 x 76 x 58	Policarbonato/ Polycarbonate	Trasparente/Transparent
RPPM62TR		Ripiano orizzontale/ Horizontal shelf	620 x 370 x 8	PMMA	Trasparente/Transparent
RPPM62AR					Arancio fluo/Fluo orange
RPPM62AZ					Blu/Blue
RPPM62GV					Giallo fluo/Fluo yellow
RPPM62RD					Rosso fluo/Fluo red
RPPM62BI					Bianco/White
RPPM62WF	Satinato/Frosted				
DBMRP101		Supporto per ripiano orizzontale, completo di N°2 ventose d'appoggio/Supporting element for horizontal shelf, n° 2 suction cups included	245 x 120 x 30	Acciaio al carbonio/ + Carbon steel	Alluminio satinato/ Glazed aluminium
DDRRP101		Doppio Supporto per ripiani orizzontali, completo di ventose d'appoggio/Supporting element for horizontal shelf,	245 x 220 x 30		Alluminio satinato/ Glazed aluminium
DK3PM3TR		Ripiano circolare con foro centrale passante, completo di attacco per fissaggio al montante verticale/ Round shelf with central hole, fixing element for vertical pole included	Ø 370	PMMA	Trasparente/Transparent
DK3PM3VD					Acquamarina/Aquamarine
DK3PM3AR					Arancio fluo/Fluo orange
DK3PM3AZ					Blu/Blue
DK3PM3GV					Giallo fluo/Fluo yellow
DK3PM3RD					Rosso fluo/Fluo red
DK3PM3BI					Bianco/White
DK3PM3WF					Satinato/Frosted
DK1PM1TR		Ripiano circolare, completo di braccio e attacco per fissaggio "a sbalzo" su montante verticale/ Round shelf, arm and overhanging connection on vertical pole included	Ø 370	PMMA	Trasparente/Transparent
DK1PM1VD					Acquamarina/Aquamarine
DK1PM1AR					Arancio fluo/Fluo orange
DK1PM1AZ					Blu/Blue
DK1PM1GV					Giallo fluo/Fluo yellow
DK1PM1RD					Rosso fluo/Fluo red
DK1PM1BI					Bianco/White
DK1PM1WF					Satinato/Frosted
RPPM32TR		Ripiano sagomato, completo di attacco per fissaggio su montante verticale. Specifico per calzature./ Shaped shelf, fixing element for vertical pole included. Specific for footwear.	320 x 185 x 8	PMMA	Trasparente/Transparent
RPPM32VD					Acquamarina/Aquamarine
RPPM32AR					Arancio fluo/Fluo orange
RPPM32AZ					Blu/Blue
RPPM32GV					Giallo fluo/Fluo yellow
RPPM32RD					Rosso fluo/Fluo red
RPPM32BI					Bianco/White
RPPM32WF					Satinato/Frosted
OT61PMTR		Pannello in acrilico per occhiali. Elementi per fissaggio a tubi verticali: inclusi. Porta fino a 23 paia di occhiali/ Acrylic panel for eyeglasses/sunglasses. Fixing elements to vertical poles: included. Can support up to 23 pairs of glasses.	610 x 8 x 1010	PMMA	Trasparente/Transparent
OT61PMWT					Monosatinato/ One side frosted
MRSP101		Morsetto per accoppiamento a pannelli sp. 2-30 mm, completo di brugole di fissaggio/ Supporting element for for panels (2-30 mm th.), M8x55 screws included	22 x 45 x 69	Policarbonato/ Polycarbonate	Trasparente/Transparent

Codice/Code	Descrizione/Description	Dim lxbxh mm	Materiale/Material	Colore/Colour	
<b>INSTALLAZIONE PAVIMENTO-SOFFITTO / FLOOR-TO-CEILING INSTALLATION:</b>					
TBEXALS200		Montante verticale estensibile da 2120 a 2550 mm <i>Extensible vertical pole. Extension range: 2120-2550 mm</i>	ø34	Alluminio+ Acciaio/ Aluminium+ Steel	Alluminio satinato/ Glazed Aluminium
TBEXALS250		Montante verticale estensibile da 2620 a 3060 mm <i>Extensible vertical pole. Extension range: 2620-3060 mm</i>	ø34	Alluminio+ Acciaio/ Aluminium+ Steel	Alluminio satinato/ Glazed Aluminium
TBEXALS300		Montante verticale estensibile da 3120 a 3400 mm <i>Extensible vertical pole. Extension range: 3120-3400 mm</i>	ø34	Alluminio+ Acciaio/ Aluminium+ Steel	Alluminio satinato/ Glazed Aluminium
<b>INSTALLAZIONE AUTOPORTANTE / SELF-STANDING INSTALLATION:</b>					
PLBCC180		Piantone in alluminio satinato Ø 34 mm, con base circolare/ <i>Aluminium pole ø 34 mm, with round base</i>	Ø34 X H 1800 mm	Alluminio+ Acciaio al carbonio/ Aluminium+ Carbon Steel	Alluminio satinato/ Glazed aluminium
PLBCC200			Ø34 X H 2000 mm		
PLBCC210			Ø34 X H 2100 mm		
<b>INSTALLAZIONE A PARETE / WALL- INSTALLATION:</b>					
WLALM200		Set composto da tubo verticale con piedino ø120 mm e braccetti per fissaggio a parete/ <i>Aluminium set composed of a vertical tube w/ø120 mm round feet and arms for wall installation</i>	Ø34 X H 2000 mm	Alluminio+ Acciaio al carbonio/ Aluminium+ Carbon Steel	Alluminio satinato/ Glazed aluminium
WLALM210			Ø34 X H 2100 mm		
WLALM250			Ø34 X H 2500 mm		
APPC60TR		Appendiera trasparente "a sbalzo", completa di attacco per fissaggio su montante verticale/ <i>Transparent waterfall arm, fixing element for vertical pole included</i>	400 x 40 x 8	PMMA	Trasparente/Transparent
APP075A1		Modulo appendiera in alluminio, completo di attacchi per fissaggio su montanti verticali/ <i>Aluminium horizontal hanging tube, fixing elements to vertical poles included</i>	ø 34 x 750 mm	Alluminio / Aluminium	Alluminio satinato/ Glazed aluminium
APP143A1		Modulo appendiera in alluminio, completo di attacchi per fissaggio su montanti verticali/ <i>Aluminium horizontal hanging tube, fixing elements to vertical poles included</i>	ø 34 x 1430 mm	Alluminio / Aluminium	Alluminio satinato/ Glazed aluminium
APP210A1		Modulo appendiera in alluminio, completo di attacchi per fissaggio su montanti verticali/ <i>Aluminium horizontal hanging tube, fixing elements to vertical poles included</i>	ø 34 x 2100 mm	Alluminio / Aluminium	Alluminio satinato/ Glazed aluminium