

## GM.001

Typology: Suspension



### Description / Descripción

Suspension lamp.  
Nickel pendant lamp and red fabric cable.  
Acrylic elastic mesh lampshade.

*Modelo colgante.  
Florón en níquel y cable textil rojo.  
Pantalla en malla elástica acrílica.*

### Light bulb / bombillas

Voltage: 220-230V / 50-60Hz

**GM.001**  1 x E27 PL E-GLOBE 32W  
 1 x E-27 LED 12W

*Bulbs not included*



### Packaging / embalaje

 1 box  
50x50x50 cm  
vol.: 0,125 m³  
Net weight: 1,5Kg

### General measures / medidas generales

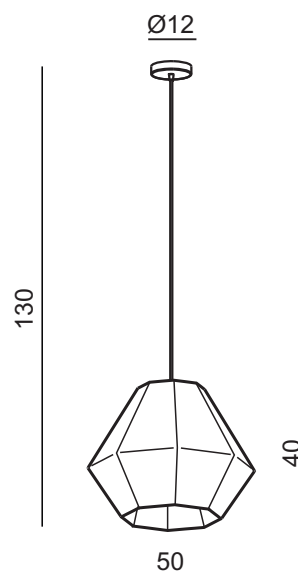

### Features & finishings / Características

Lampshade <i>Pantalla</i>	<b>Acrylic elastic mesh</b> Malla elástica acrílica
Canopy <i>Florón</i>	<b>Nickel</b> Níquelado
Electrical cable <i>Cable eléctrico</i>	<b>Red fabric cable</b> Textil rojo

### Certifications:



*Light for indoor use only*

### Various sizes / Otras medidas

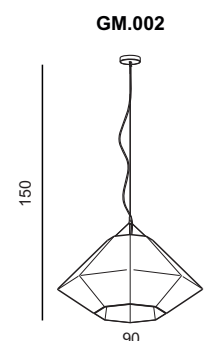

## GM.002

Typology: Suspension

### Description / Descripción

Suspension lamp.  
Nickel pendant lamp and red fabric cable.  
Acrylic elastic mesh lampshade.



*Modelo colgante.*

*Florón en níquel y cable textil rojo.*

*Pantalla en malla elástica acrílica.*

### Light bulb / bombillas

Voltage: 220-230V / 50-60Hz

**GM.002**  3 x E27 PL E-GLOBE 32W  
 3 x E-27 LED 12W

*Bulbs not included*



### Packaging / embalaje

 1 box  
90x90x50 cm  
vol.: 0,4 m³  
Net weight: 3Kg

### General measures / medidas generales

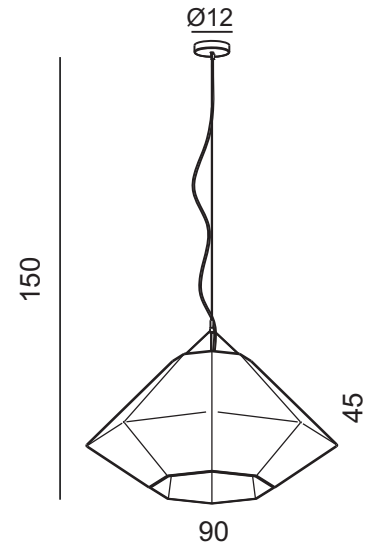

### Features & finishings / Características

Lampshade <i>Pantalla</i>	<b>Acrylic elastic mesh</b> Malla elástica acrílica
Canopy <i>Florón</i>	<b>Nickel</b> Níquelado
Electrical cable <i>Cable eléctrico</i>	<b>Red fabric cable</b> Textil rojo

### Certifications:



*Light for indoor use only*

### Various sizes / Otras medidas

