

Déjà-vu

design naoto fukasawa
2005

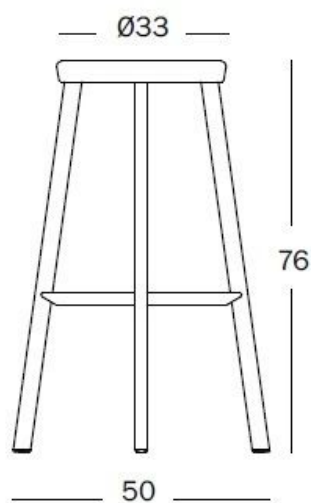



High bar stool.
Legs in extruded aluminium polished or painted. Seat and foot-rest in die-cast aluminium, polished or painted.

 Please note: flame-retardant

— Felt pads available, with surcharge.
SD282 KIT.FEL 2,50

SD282 Polished





SD282A Assembled version.
Fixed supplement (net)

	Kg	7,50	m ³	0,046 (0,82x0,41x0,13)	
		6,00		9401.79.00	
	Kg	7,50	m ³	0,248 (0,82x0,55x0,55)	
		6,00		9401.79.00	

! Suitable for outdoor use.

SD292 Colours (seat, legs and foot-rest):
black 5130
red-purple news
sand beige news

SD292A Assembled version.
Fixed supplement (net)

	Kg	7,50	m ³	0,046 (0,82x0,41x0,13)		
		6,00		9401.79.00		
	Kg	7,50	m ³	0,248 (0,82x0,55x0,55)		
		6,00		9401.79.00		

