

LINK S129

Hee Welling | 2012

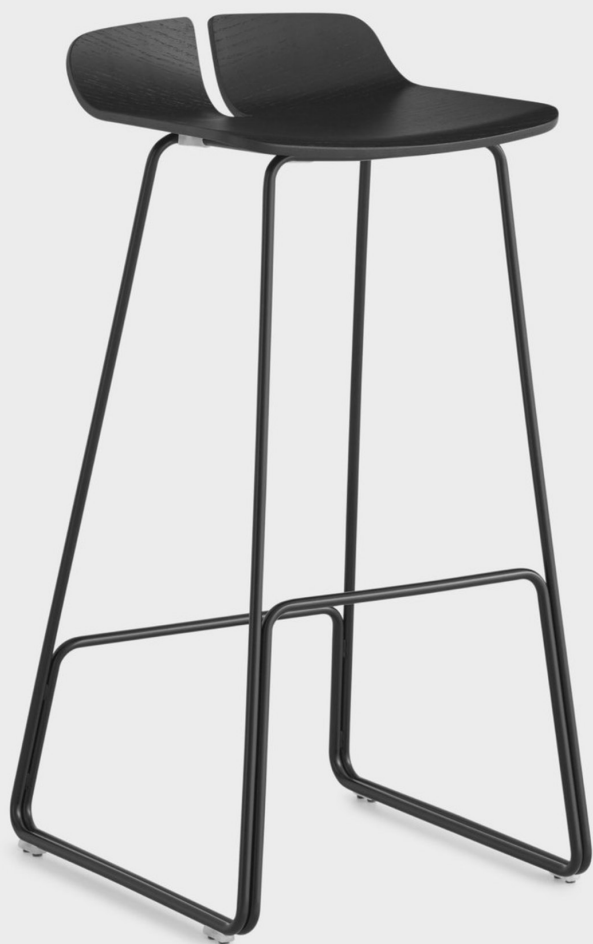

LINK

Hee Welling | 2012

A small gap, a break in the line, and the LINK stool takes shape. It is light, as its narrow metal base and its wood seat suggest, and gently bends to create the backrest. In the natural wood version, the veining enhances the soft profile and embraces like a very fresh leaf.



LINK

Hee Welling | 2012

S129 Metal frame H75

LINK | S128 S129

Stool in two heights with frame in sandblasted stainless steel Aisi 304 or powder coated with glides in polythene and felt. Seat in plywood in several finishes.

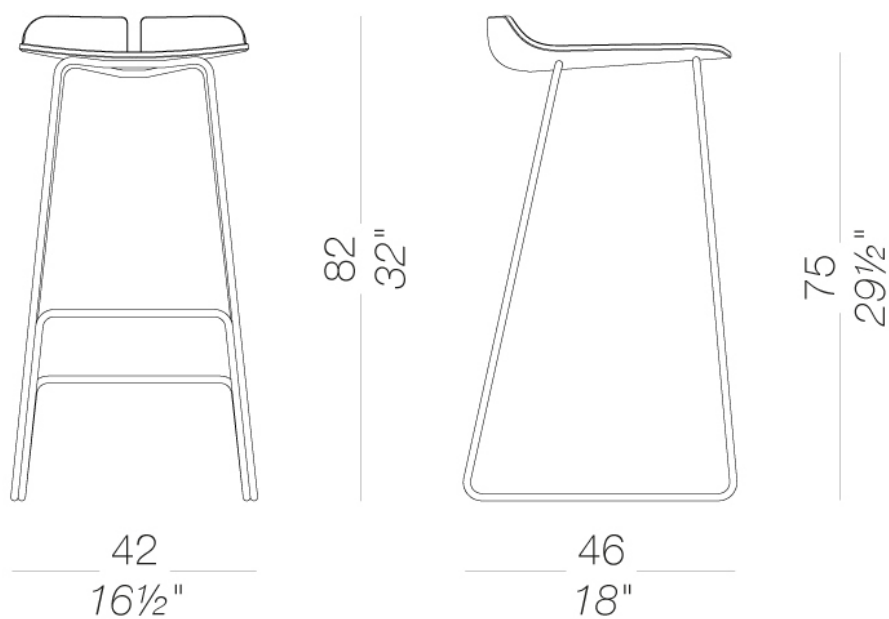

LINK S129

Hee Welling | 2012

frame



powder coating
black
1 Colors

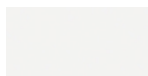

powder coating
white
1 Colors



metal
stainless steel
1 Colors

shell



wood
blanch oak
1 Colors

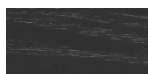

wood
black open pore
1 Colors



wood
oak dark walnut
1 Colors

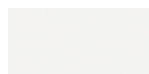

lacquered
white lacquered
1 Colors

consult the portfolio for the range of colors, fabrics, eco-leather, soft-leather.

use and maintenance instructions

Clean all parts in wood, leather, fabric and metal with a damp cloth or a diluted neutral cleaner. Do not use cleaners with alcohol, bleach, solvent or abrasive products. Any liquid spilt on the product must be wiped up immediately. When lifting or moving the product, hold it on the structure and not under the seat. The product should not be subjected to unbalanced weights, as it is designed for a proper rest on the foothold (on four legs or on the base). Our company relieves from any responsibility in case of damage caused to fragile floors. Avoid any improper use of the product: do not step on the product, on the footrest or on the armrests. Avoid any movements that could compromise the proper functionality of the product or the safety of the users. Wood and leather, being natural materials, could be easily damaged. Small impurities or imperfections are within quality standard range. Do not expose the product to weather conditions or atmospheric agents, nor to heat sources over 40°C. Also products for outdoor use could be afflicted by atmospheric agents. The product could undergo possible exterior changes due to particular exposure to heat, humidity and saltiness. An appropriate and frequent maintenance and cleaning of the product enhances its durability. The product could change colour and shade, if exposed to direct sunlight. Maintenance has to be carried out by experienced staff. Dispose of the package only after assembling the product, in order to avoid the loss of ironmongery and components. Once the product has been dismantled, the product itself or its components must be given to the public garbage disposal system, according to the legislation in force.